

VACON 100
AC DRIVES

**LONWORKS OPTION BOARD
INSTALLATION AND
USER'S MANUAL**

DRIVE CENTRE 
Industrial Automation Systems Integrators

57 Galaxy Blvd., Units 1 & 2, Toronto, ON M9W 5P1
TEL: (416) 231-6767
www.drivecentre.ca

INDEX

Document: DPD00169A

Version release date: 13.8.09

Safety	3
Danger	3
Warnings	4
Earthing and earth fault protection	5
LonWorks - general info	7
LonWorks technical data	8
General	8
Physical media and wiring	9
Profiles	9
Variable speed profile	9
Layout, connections and installation	11
LonWorks OPT-C4 option board	11
Connections	11
LED indications	12
Installation	13
Prepare for use through LonWorks	15
Commissioning	19
I/O and Hardware menu (M5)	19
LonWorks board parameters	19
LonWorks interface	21
XIF file	21
General	21
Input Network Variables	23
Output network variables	26
Network configuration variables	28
Fault tracing	31
Typical fault conditions	31
Quick Setup	33

1. SAFETY

This manual contains clearly marked cautions and warnings which are intended for your personal safety and to avoid any unintentional damage to the product or connected appliances.

Please read the information included in cautions and warnings carefully.

The cautions and warnings are marked as follows:







	= DANGER! Dangerous voltage
	= WARNING or CAUTION
	= Caution! Hot surface

Table 1. Warning signs

1.1 DANGER

- 

The **components of the power unit of Vacon 100 are live** when the AC drive is connected to mains potential. Coming into contact with this voltage is **extremely dangerous** and may cause death or severe injury.
- 

The **motor terminals U, V, W and the brake resistor terminals are live** when Vacon 100 is connected to mains, even if the motor is not running.
- 

After disconnecting the AC drive from the mains, **wait** until the indicators on the keypad go out (if no keypad is attached see the indicators on the cover). Wait 5 more minutes before doing any work on the connections of Vacon100. Do not open the cover before this time has expired. After expiration of this time, use a measuring equipment to absolutely ensure that no voltage is present. **Always ensure absence of voltage before starting any electrical work!**
- 

The control I/O-terminals are isolated from the mains potential. However, the **relay outputs and other I/O-terminals may have a dangerous control voltage** present even when Vacon 100 is disconnected from mains.
- 

Before connecting the AC drive to mains make sure that the front and cable covers of Vacon 100 are closed.
- 

During a ramp stop (see the Application Manual), the motor is still generating voltage to the drive. Therefore, do not touch the components of the AC drive before the motor has completely stopped. Wait until the indicators on the keypad go out (if no keypad is attached see the indicators on the cover). Wait additional 5 minutes before starting any work on the drive.

1.2 WARNINGS



Vacon 100 AC drive is meant for **fixed installations only**.



Do not perform any measurements when the AC drive is connected to the mains.



The **earth leakage current** of Vacon 100 AC drives exceeds 3.5mA AC. According to standard EN61800-5-1, a **reinforced protective ground connection** must be ensured. See chapter 1.3.



If the AC drive is used as a part of a machine, the **machine manufacturer is responsible** for providing the machine with a **supply disconnecting device** (EN 60204-1).



Only **spare parts** delivered by Vacon can be used.



At power-up, power brake or fault reset **the motor will start immediately** if the start signal is active, unless the pulse control for Start/Stop logic has been selected. Furthermore, the I/O functionalities (including start inputs) may change if parameters, applications or software are changed. Disconnect, therefore, the motor if an unexpected start can cause danger.



The **motor starts automatically** after automatic fault reset if the auto restart function is activated. See the Application Manual for more detailed information.



Prior to measurements on the motor or the motor cable, disconnect the motor cable from the AC drive.



Do not touch the components on the circuit boards. Static voltage discharge may damage the components.



Check that the **EMC level** of the AC drive corresponds to the requirements of your supply network.

1.3 EARTHING AND EARTH FAULT PROTECTION



CAUTION!

The Vacon 100 AC drive must always be earthed with an earthing conductor connected to the earthing terminal marked with \perp .

The earth leakage current of Vacon 100 exceeds 3.5mA AC. According to EN61800-5-1, one or more of the following conditions for the associated protective circuit shall be satisfied:

- a) The protective conductor shall have a cross-sectional area of at least 10 mm² Cu or 16 mm² Al, through its total run.
- b) Where the protective conductor has a cross-sectional area of less than 10 mm² Cu or 16 mm² Al, a second protective conductor of at least the same cross-sectional area shall be provided up to a point where the protective conductor has a cross-sectional area not less than 10 mm² Cu or 16 mm² Al.
- c) Automatic disconnection of the supply in case of loss of continuity of the protective conductor.

The cross-sectional area of every protective earthing conductor which does not form part of the supply cable or cable enclosure shall, in any case, be not less than:

- 2.5mm² if mechanical protection is provided or
- 4mm² if mechanical protection is not provided.

The earth fault protection inside the AC drive protects only the drive itself against earth faults in the motor or the motor cable. It is not intended for personal safety.

Due to the high capacitive currents present in the AC drive, fault current protective switches may not function properly.



Do not perform any voltage withstand tests on any part of Vacon 100. There is a certain procedure according to which the tests shall be performed. Ignoring this procedure may result in damaged product.

NOTE! You can download the English and French product manuals with applicable safety, warning and caution information from www.vacon.com/downloads.

REMARQUE Vous pouvez télécharger les versions anglaise et française des manuels produit contenant l'ensemble des informations de sécurité, avertissements et mises en garde applicables sur le site www.vacon.com/downloads.

2. LONWORKS - GENERAL INFO

Vacon 100 frequency converters can be connected to the LonWorks® network using a fieldbus board. The converter can then be controlled, monitored and programmed from the Host system.

LONWORKS technology has been developed by Echelon Corporation. LONWORKS network is used in applications like industry and building automation, controlling household electronics, medical instrumentation and many others. The target of the LONWORKS network is to provide a common vendor independent communication network for intelligent devices.

In a LONWORKS network, no central control or master-slave architecture is needed. Nodes on a network communicate with each other using LonTalk® protocol. Interoperable nodes use Standard Network Variable Types (SNVT) for communicating over the network. The definition of an SNVT includes units, a range, and an increment. Vacon option board uses only Standard Network Variable Types for the data types.

All network variables are either input (data is coming from the network to the device) or output (data is sent to the network by the device) network variables. When network variables on different nodes on the network have been bound together by an installation tool, passing of data is automatic between the right nodes. Only the same type of network variables can be bound together, so it is very important to have compatible interfaces.

If you need further information related to LonWorks, please contact fieldbus@vacon.com

3. LONWORKS TECHNICAL DATA

3.1 GENERAL

Connections and communications	Interface	Pluggable connector (5 mm)
	Channel type	TP/FT-10
	Transfer cable	Shielded Twisted Pair
	Baud rate	78 Kbit/s
Environment	Ambient operating temperature	-10°C...50°C
	Storing temperature	-40°C...70°C
	Humidity	<95%, no condensation allowed
	Altitude	Max. 1000 m
	Vibration	0.5 G at 9...200 Hz
Safety	Fulfils EN50178 standard	

Table 2.

3.2 PHYSICAL MEDIA AND WIRING

LONWORKS networks can be implemented on many different physical media. Vacon OPT-C4 option board is equipped with an FT-X1 transceiver supporting the Free Topology transformer coupled network, which allows the network wire to be connected as bus, star, loop or combination of these. This media reaches a communication speed of 78kBits/s. The FT-X1 transceiver is compatible with Echelon's LPT-10 Link Power Transceiver, and these transceivers can communicate with each other on a single twisted pair cable.

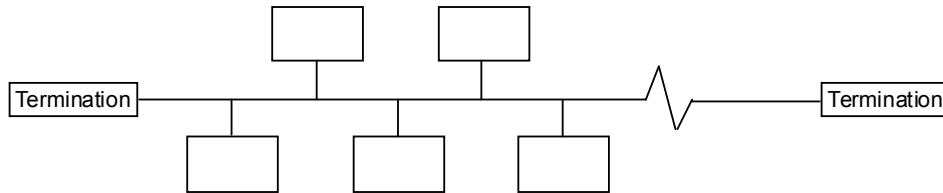

Figure 1. Doubly terminated bus topology

The doubly terminated bus topology is recommended to be used. However, also singly terminated, star or loop topologies can be used with OPT-C4 option board.

Up to 64 FTT-10 transceiver nodes are allowed per network segment, the individual segments can be connected together by a router. See Table 3 for possible cable types and cable lengths for FTT-10. Even if unshielded cable types are possible to be used with this type of transceiver, **it is still highly recommended to use only shielded cables with frequency converters.** Attention should be paid to proper grounding of the shield to ensure bus operation. Grounding of the shield should be done at both ends of the cable.

Cable type	Max. doubly terminated bus length	Max. free topology wire length	Max. node-to-node distance
JY (St) Y 2x2x0.8mm LONAK 2x2x0,8 (shielded)	900 m	500 m	320 m

Table 3.

3.3 PROFILES

LonMark Functional Profiles describe in detail the application layer interface, including the network variables, configuration properties, and default and power-up behaviors required on LonMark devices for specific, commonly used control functions.

3.3.1 VARIABLE SPEED PROFILE

Leading manufacturers of drive technology have jointly defined the LonMark profile. The profile specifies how the drives are to be parameterized and how the setpoints and actual values are to be transmitted. This enables drives from different vendors to be exchanged. The profile contains necessary specifications for speed control and positioning. It specifies the basic drive functions while leaving sufficient freedom for application-specific expansions and further developments.

4. LAYOUT, CONNECTIONS AND INSTALLATION

Vacon LonWorks Fieldbus Board is connected to the fieldbus through 3-pin pluggable bus connector. The communication with the control board takes place through the standard Vacon Interface Board Connector.

4.1 LONWORKS OPT-C4 OPTION BOARD

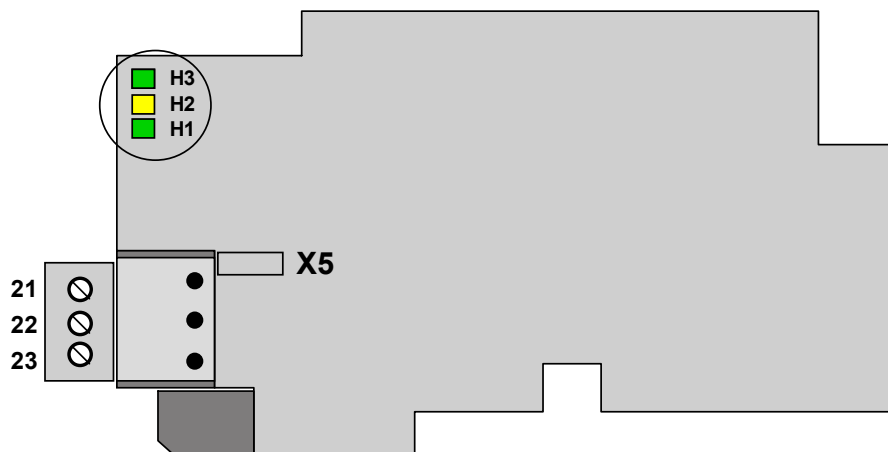

Figure 2.

4.1.1 CONNECTIONS

Signal	Connector	Description
A1	21	Data
A2	22	Data
Shield	23	Shield

Table 4.

4.1.2 LED INDICATIONS

The three LED indications (see Figure 2) next to the connector show the present statuses of the Neuron (green H3), the LonWorks board (yellow H2) and the Fieldbus Module (green H1). From the user's viewpoint, the first two are the most significant.

Neuron status (H3) GREEN

LED is	Meaning:	State code
OFF	Configured	4
ON	Applicationless and Unconfigured	3
Flashing	Unconfigured	2

Board status LED (H2) YELLOW

LED is	Meaning:
OFF	Option board not activated
ON	Option board in initialisation state waiting for activation command from the frequency converter
Blinking fast (once/1 s)	Option board is activated and in RUN state Option board is ready for external communication
Blinking slow (once/5 s)	Option board is activated and in FAULT state Internal fault on option board

Bus status LED (H1) GREEN

LED is	Meaning:
OFF	Fieldbus module is activated Parameters received and module activated Module is waiting for messages from the bus
ON	Fieldbus module is activated Parameters received and module activated Module is waiting for messages from the bus
Blinking very fast for 5s (once/0.2 s)	Fieldbus module has received a wink request
Blinking fast (once/1 s)	Module is activated and receiving messages from the bus
Blinking slow (once/5 s)	Module is in FAULT state No messages from Net within the watchdog time Bus broken, cable loose

4.2 INSTALLATION

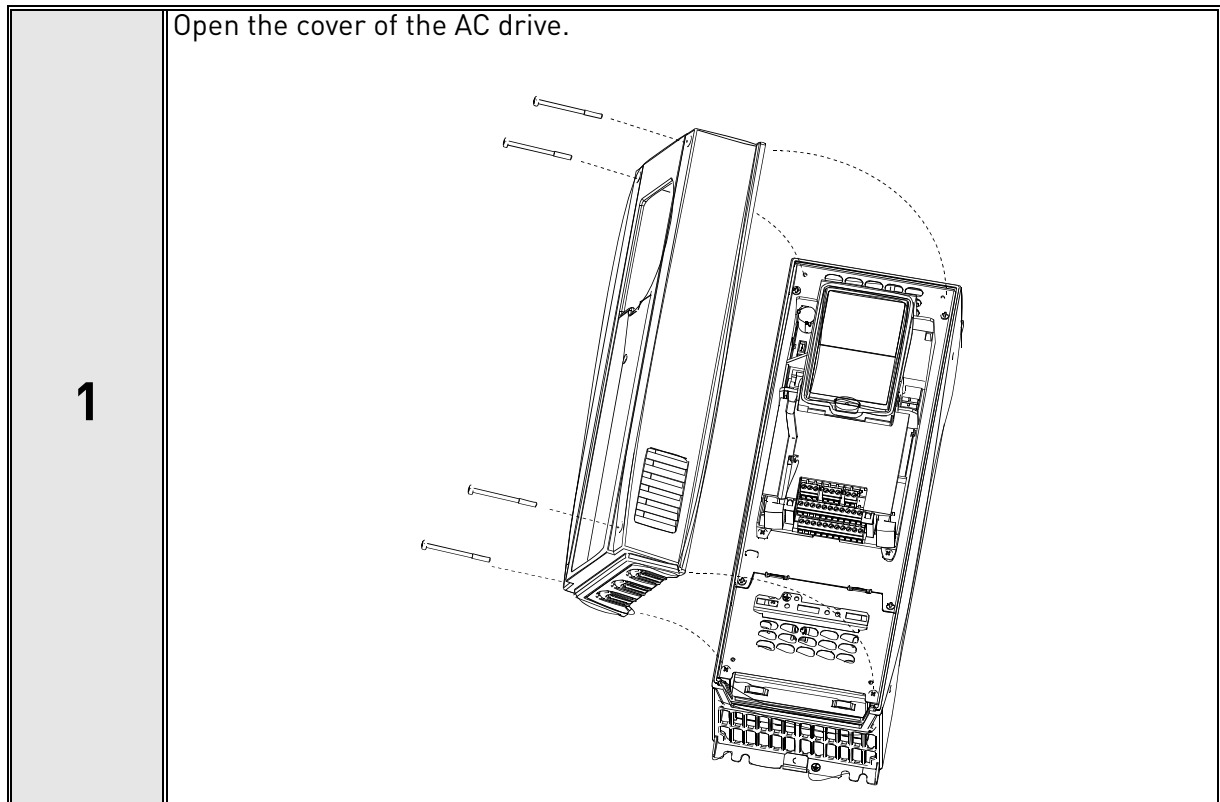

The relay outputs and other I/O-terminals may have a dangerous control voltage present even when Vacon 100 is disconnected from mains.

2

Make sure that the sticker on the connector of the board says "dv" (dual voltage). This indicates that the board is compatible with Vacon 100. See below:

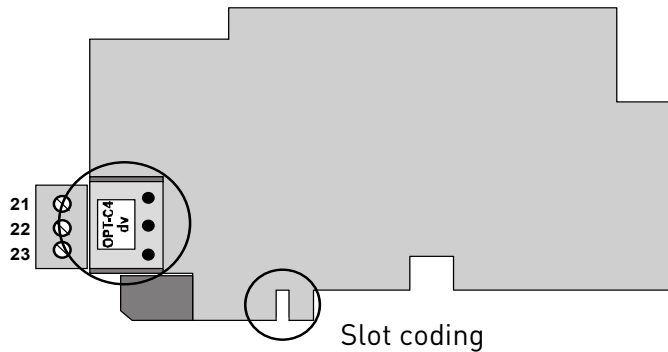

NOTE: Incompatible boards cannot be installed on Vacon 100. Compatible boards have a slot coding that enable the placing of the board (see above)

3

Open the inner cover (1) to reveal the option board slots (D,E) and install the fieldbus board (2) into slot D or E. Close the inner cover. See Figure below.

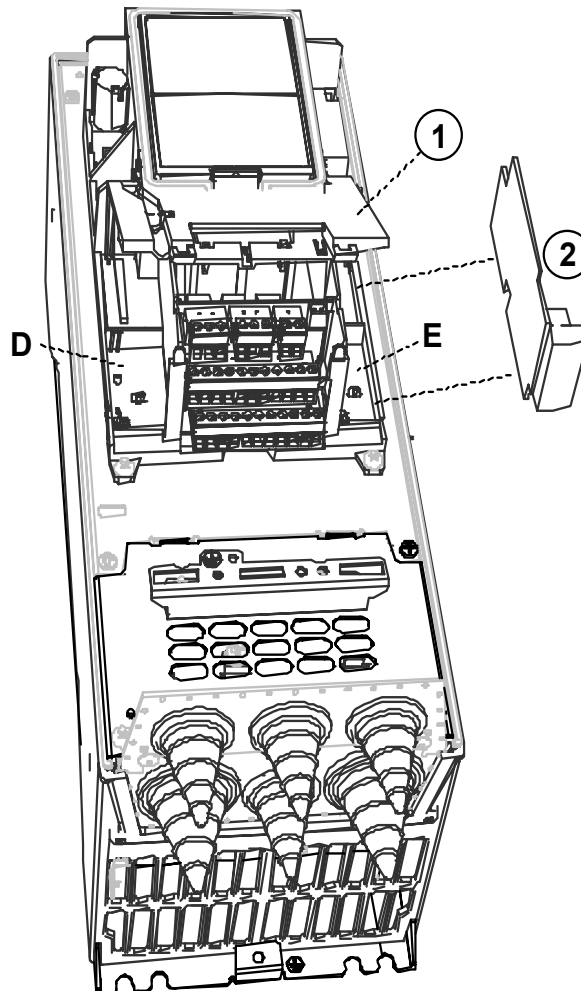

4.3 PREPARE FOR USE THROUGH LONWORKS

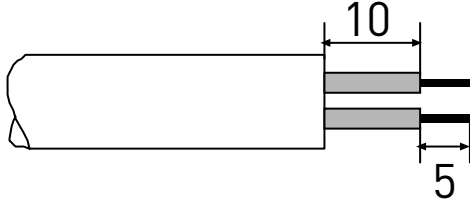
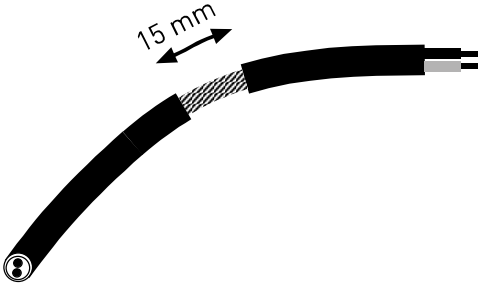
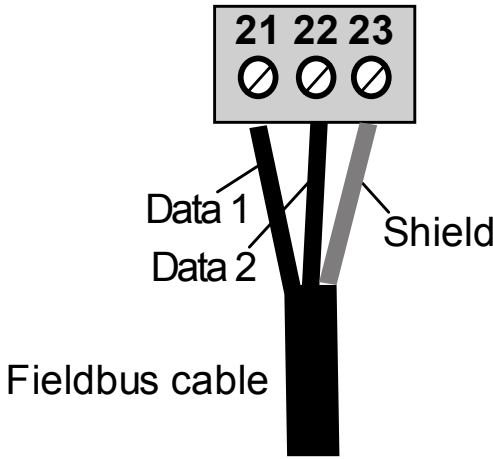
4	<p>Strip about 15 mm of the fieldbus cable (see specification on page 9) and cut off the grey cable shield. Remember to do this for both bus cables (except for the last device).</p> <p>Leave no more than 10 mm of the cable outside the terminal block and strip the cables at about 5 mm to fit in the terminals. See picture below.</p>  <p>Also strip the cable now at such a distance from the terminal that you can fix it to the frame with the grounding clamp. Strip the cable at a maximum length of 15 mm. Do not strip the aluminum cable shield!</p> 
5	<p>Then connect the cable to its appropriate terminals on LonWorks Option Board terminal block.</p> 

6

Using the cable clamp included in the delivery of the drive, ground the shield of the LonWorks cable to the frame of the AC drive.

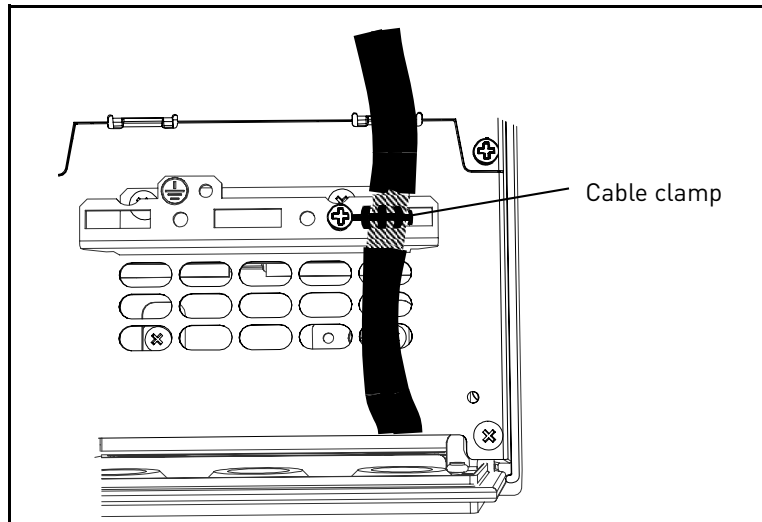

7

If Vacon 100 is the last device on the bus, the bus termination must be set. To assure a proper data transmission, termination of the network segments is required. Depending on the type of network, either one or two terminations are necessary. Free topology network segment requires only one termination whereas a doubly terminated bus topology requires two.

The jumper X5 on the Vacon LonWorks board must be set accordingly.

- Use 94-ohm termination resistance when only one termination is needed
- 47-ohm termination resistance for two terminations

See also step 10 on page 17.

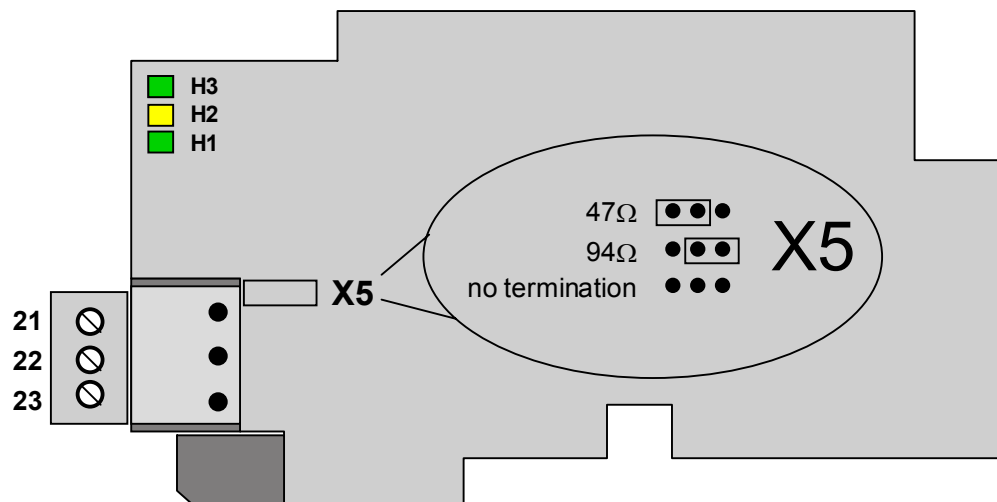

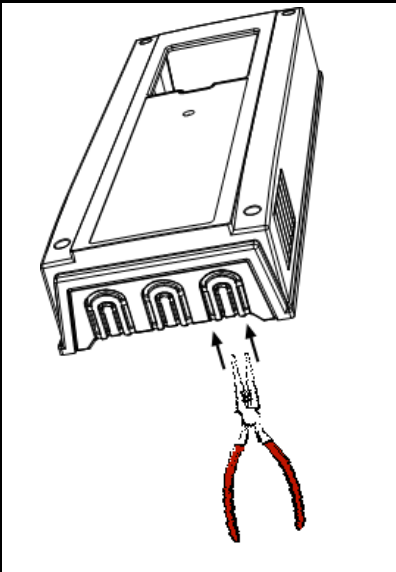
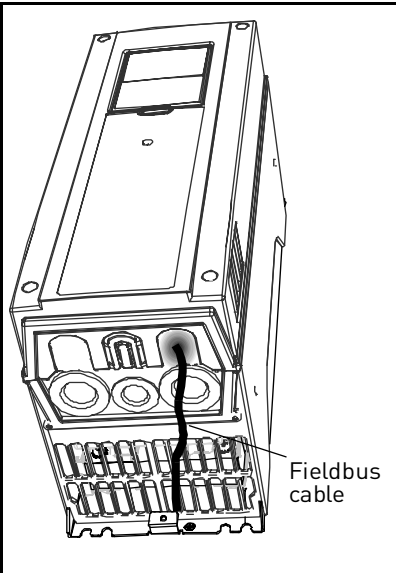
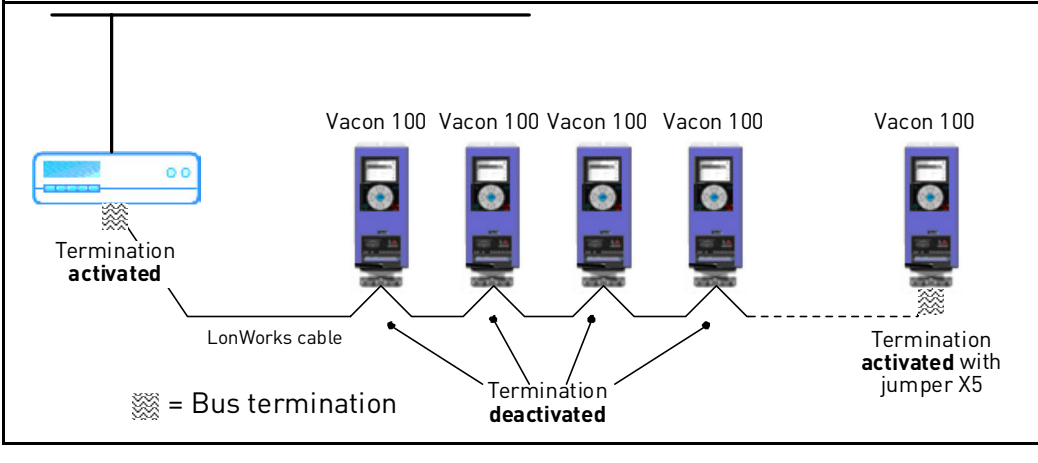
<p style="text-align: center; font-size: 24pt; font-weight: bold;">8</p>	<p>Unless already done for the other control cables, cut free the opening on the AC drive cover for the fieldbus cable (protection class IP21). NOTE: Cut the opening on the same side you have installed the board in!</p>	
<p style="text-align: center; font-size: 24pt; font-weight: bold;">9</p>	<p>Remount the AC drive cover and run the cable as shown in picture. NOTE: When planning the cable runs, remember to keep the distance between the fieldbus cable and the motor cable at a minimum of 30 cm.</p>	 <p style="text-align: right;">Fieldbus cable</p>
<p style="text-align: center; font-size: 24pt; font-weight: bold;">10</p>	<p>The bus termination must be set for the first and the last device of the fieldbus line. See picture below. See also step 7 on page 16. We recommend that the first device on the bus and, thus, terminated was the Master device.</p> 	

5. COMMISSIONING

Please read first the commissioning chapter in Vacon 100 HVAC Installation manual (Download the latest version of the manual on www.vacon.com).

5.1 I/O AND HARDWARE MENU (M5)

The I/O and Hardware menu makes it possible for the user

- 1) to see what expander boards are connected to the control board and
- 2) to reach and edit the parameters associated with the expander board.
- 3) Software information

The navigation path to the fieldbus parameters may differ from application to application. The exemplary paths below apply to the Vacon 100 HVAC drive.

1. Set fieldbus parameters (M5.x.3). See below.

Navigate: Main Menu > I/O and Hardware (M5) > OPTC4 (M5.x) > parameters (M.x.3) > Select parameter > Edit

2. Select 'Fieldbus control' as the Remote Control Place.

Navigate: Main Menu > Quick Setup (M1) > Rem. Ctrl. Place (P1.15)

OR

Navigate: Main Menu > Parameters (M3) > Start/Stop Setup (M3.2) > Rem. Ctrl. Place (P3.2.1)

3. Choose source of reference.

Navigate: Main Menu > Parameters (M3) > References (M3.3)

5.2 LONWORKS BOARD PARAMETERS

Code	Parameter	Min	Max	Unit	Default	ID	Description
M5.x.3.1	Service Pin	0	1		0		Broadcasts a service pin message to the network

6. LONWORKS INTERFACE

Features of the LonWorks interface:

- Direct control of Vacon 100 (e.g. Run, Stop, Direction, Speed reference, Fault reset)
- Full access to all Vacon 100 parameters
- Monitor Vacon 100 status (e.g. Output frequency, Output current, Fault code)

6.1 XIF FILE

XIF file tells network-management tools how to communicate and recognize a device. It can be downloaded from www.vacon.com, and it is also included with the shipped Support CD. It contains Program ID, NVs, CPs, functional blocks, etc.

6.2 GENERAL

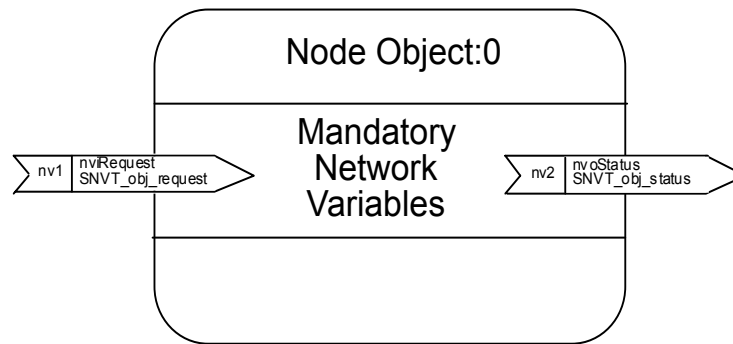

Figure 3. The node object diagram

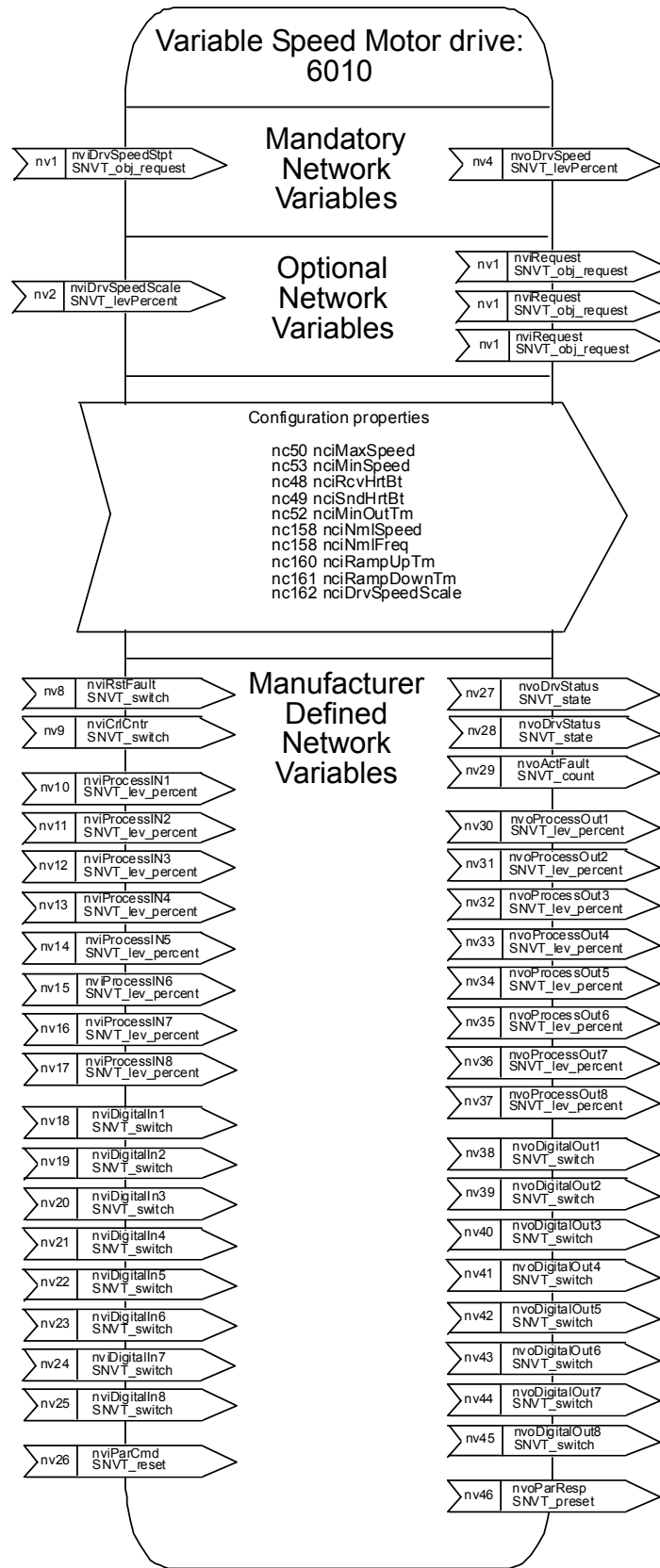

Figure 4. The Variable Speed Motor Drive object diagram

6.3 INPUT NETWORK VARIABLES

Function	Variable Name	SNVT Type	Min. value	Max. value
Node Object request	nviRequest	SNVT_obj_request		
Driver speed setpoint	nviDrvSpeedStpt	SNVT_switch	n / a	n / a
Driver set point speed scaling	nviDrvSpeedScale	SNVT_lev_percent	-163.840%	163.830%
Reset fault	nviRstFault	SNVT_switch	n / a	n / a
Clear kWh trip or Drive total running hours trip counters	nviClrCntr	SNVT_switch	1	2
Process In Data	nviProcessIn1..8	SNVT_lev_percent	0	65535
Digital Inputs	nviDigitalIn1..8	SNVT_switch	0	4
Parameter Set	nviParCmd	SNVT_preset	n / a	n / a

Table 5. Input network variables

nviRequest

This input network variable provides the mechanism to request a particular mode for the Node object or the Variable Speed Motor Drive object within a node. Supported requests are RQ_NORMAL, RQ_UPDATE_STATUS, RQ_CLEAR_STATUS, RQ_REPORT_MASK, RQ_DISABLED, RQ_ENABLE and RQ_CLEAR_ALARM.

nviDrvSpeedStpt

This input network variable provides control and a low resolution speed setpoint.

State	Value	Command
0	NA	Stop
1	0	0%
1	1 to 200	0.5 to 100%
1	201 to 255	100.0%
0xFF	NA	Auto

Table 6.

nviDrvSpeedScale

This input network variable provides scaling for nviDrvSpeedStpt. Negative values indicate a motor direction in reverse. For example, if the nviDrvSpeedStpt value is 50% and nviDrvSpeedScale -150%, then the actual speed setpoint is -75%, or 0.75 times the nominal speed in reverse direction. The valid range is -163,840% to 163,830. The value 0x7FFF (+163,835%) will be handled as an invalid value. Default value is determined by nciDrvSpeedScale. This value will be adopted at power-up and in case of not receiving an update within the specified Receive Heartbeat time.

nviRstFault

This input network variable provides a fault reset. Setting value 1 for State and a non-zero value for Value will reset an active fault in Vacon 100. Default value is 0; 0

State	Value	Command
0	any	no action (0; 0)
1	0	no action (0; 1)
1	> 0	reset fault (200 ; 0)
-1(0xFF)	any	invalid (no action)

Table 7.

nviClrCntr

This input network variable provides a mechanism to clear the kWh trip counter or the Drive total running hours trip counter.

1 = MWh trip counter

2 = Operation day trip counter

nviProcessIn1..8

These input network variables are sent directly to the application (see more detailed explanation in chapter 6.5 Process data) The valid range is 0 to 65535 (-163,840 to 163,835).

nviDigitalIn1..8

These input network variables are sent directly to the application (see more detailed explanation in chapter 6.5 Process data) Default value is 0; 0.

State	Value	Command
0	any	off (0; 0)
1	0	off (0; 1)
1	> 0	on (200 ; 0)
-1(0xFF)	any	invalid (no action)

Table 8.

nviParCmd

This input network variable is used to read and write the parameters. The parameter addresses are determined in the application. Every parameter and actual value has been given an ID number in the application. The ID numbering of the parameter as well as the parameter ranges and steps can be found in the application manual in question. The parameter value must be given without decimals. Find the ID numbers of each parameter/actual value in the application manual. The ID numbers are grouped as follows:

Parameter ID	Group	Description
0	Not used	
1 ... 98	Actual Values	
37	Active Fault Code	
100	Not used	
101... 899	Parameter	
900 ... 999	Reserved	Reserved for LonWorks board internal usage
1000	Not used	
1001...1999	Parameter	

Table 9.

Examples

Data format in examples is:

- learn selector <byte(3) byte(2) byte(1) byte(0)> day hour minute second millisecond
x = meaningless

Example1

Write to parameter number 102 (Max frequency "HVAC Application par. ID102") value 4500 (45Hz).

Write command to nviParSet

- LN_LEARN_CURRENT 102 <x x 11 94> x x x x

If the write command is successful then nvoParOut value is

- LN_LEARN_CURRENT 102 <0 0 11 94> 0 0 0 0

If the write command fails then nvoParOut value is

- LN_NUL 102 <0 0 11 94> 0 0 0 0

Example2

Read parameter number 112 (Nominal speed of the motor "HVAC Application par. ID112") default value 1440 (1440 rpm).

Read command to nviParSet

- LN_RECALL 112 <x x x x> x x x x

If the read command is successful then nvoParOut value is

- LN_RECALL 112 <0 0 5 A0> 0 0 0 0

If the read command fails then nvoParOut value is

- LN_LN_NUL 112 <0 0 0 0> 0 0 0 0

6.4 OUTPUT NETWORK VARIABLES

Function	Variable Name	SNVT Type	Min. Value	Max. Value
Node Object status	nvoStatus	SNVT_obj_status		
Drive speed feedback	nvoDrvSpeed	SNVT_lev_percent	-163.840%	+163.830%
Actual motor current	nvoDrvCurnt	SNVT_amp	0.0A	3276.7A
Actual drive power	nvoDrvPwr	SNVT_power_kilo	0,0 kW	6553,5 kW
Drive total running hours	nvoDrvRunHours	SNVT_time_hour	0 h	65535
Status word	nvoDrvStatus	SNVT_state	n/a	n/az
kWh trip counter	nvoDrvEnrgy	SNVT_elect_kwh	0kWh	65535kWh
Active fault code	nvoActFault	SNVT_count	0	41
Process Out	nvoProcessOut1..8	SNVT_lev_percent	0	65535
Digital Out	nvoDigitalOut1..8	SNVT_switch	0	4
Parameter Out	nvoParResp	SNVT_preset		

Table 10. Output network variables

NvoStatus

This output network variable reports the status for Node object or Variable Speed Motor Drive object

Field	Description
object_id	ID of object within node
invalid_id	1 means requested ID is not implemented in this node
invalid_request	1 means request for unimplemented function
disabled	1 means object disabled
electrical_fault	1 means drive is faulted
in_alarm	1 means drive is in alarm
report_mask	1 means status is an event mask

Table 11.

nvoDrvSpeed

This output network variable provides the speed of the drive as a percentage of the nominal speed.

nvoDrvCurnt

This output network variable provides the drive output current in amperes.

nvoDrvPwr

This output network variable provides the drive output power in kW.

nvoDrvRunHours

This output network variable provides the drive resettable operation time counter for the motor in running hours. The maximum value for used SNVT is 65535 h. On the frequency converter the value can go much higher. If the counter exceeds the SNVT's maximum value, the network variable stays at its maximum. In such cases the real value can be seen on Vacon 100 HVAC operating keypad.

nvoDrvStatus

This output network variable provides the drive status.

Bit	Description	
	Value = 0	Value = 1
0	Not Ready	Ready
1	FC stopped	Running
2	Clockwise	Counterclockwise
3	No fault	Fault active
4	No warning	Warning active
5	Reference not Actual value	Reference = Actual value

Table 12. Status word bit descriptions

nvoDrvEnergy

This output network variable provides the drive resettable energy consumption counter. The maximum value for used SNVT is 65535 kWh. On the frequency converter the value can go much higher. If the counter exceeds the SNVT's maximum value, the network variable stays at its maximum. In such cases the real value can be seen on Vacon 100 HVAC operating keypad.

nvoActFault

This output network variable provides the drive active fault code. If the value is 0 the frequency converter has no fault. See the fault code list in Vacon 100 HVAC User's Manual for fault identification.

nvoProcessOut1..8

These output network variables are sent directly from the application (see more detailed explanation in chapter 6.5 Process data) The valid range is 0 to 65535 (-163,840 to 163,835)

nvoDigitalOut1..8

These output network variables are sent directly from the application (see more detailed explanation in chapter 6.5 Process data).

state	value	command
0	0	off (0; 0)
1	200 (0xC8)	on (200; 1)
-1 (0xFF)	any	invalid (NULL)

Table 13.

nvoParResp

explained in chapter nviParSet.

6.5 NETWORK CONFIGURATION VARIABLES

Function	Variable Name	SNVT Type
Maximum motor speed	nciMaxSpeed	SCPTmaxSetpoint
Minimum motor speed	nciMinSpeed	SCPTminSetpoint
Receive heartbeat time	nciRcvHrtBt	SCPTmaxRcvTime
Send heartbeat time	nciSndHrtBt	SCPTmaxSndTime
Minimum output time	nciMinOutTime	SCPTminSndTime
Nominal motor speed in RPM	nciNmlSpeed	SCPTnomRPM
Nominal motor frequency	nciNmlFreq	SCPTnomFreq
Minimum ramp up time	nciRampUpTm	SCPTrampUpTm
Minimum ramp down time	nciRampDownTm	SCPTrampDownTm
Default value for nviDrvSpeedScale	nciRampDownTm	SCPTdefScale

Table 14. Network configuration variables

nciMaxSpeed

This configuration property is used to define the maximum speed of a motor. The value is entered as a percentage of nominal speed in RPM, as defined by the Nominal Speed (nciNmlSpeed) configuration value. The value of the maximum speed must be validated against the value of the minimum speed as follows:

$$-163.840 < \text{minimum speed} < \text{maximum speed} < 163.830$$

nciMinSpeed

This configuration property is used to define the minimum speed of the motor. The value is entered as a percentage of nominal speed in RPM, as defined by the Nominal Speed (nciNmlSpeed) configuration value. The value of the minimum speed must be validated against the value of the maximum speed as follows:

$$-163.840 < \text{minimum speed} < \text{maximum speed} < 163.830$$

nciRcvHrtBt

This configuration property is used to control the maximum time that elapses after the last update of the network variables nviDrvSpeedStpt or nviDrvSpeedScale before the VSD object starts to use the default values.

nciSndHrtBt

This configuration property defines the maximum period that expires before the network variables nvoDrvSpeed, nvoDrvCurnt and nvoDrvPwr are automatically updated.

nciMinOutTime

This configuration property defines the minimum period of automatic network variable transmission.

nciNmlSpeed

This configuration property is used to provide the nominal speed of the motor in RPM. This value is necessary to determine the minimum and maximum speeds for the motor, based on the configuration properties nciMinSpeed, nciMaxSpeed (entered as a percentage of nominal speed).

nciNmlFreq

This configuration property is used to provide the nominal frequency for the motor.

nciRampUpTm

Defines the acceleration time for Vacon 100 HVAC. The valid range is 0.0 to 6,553.4 sec (0.1 sec).

nciRampDownTm

Defines the deceleration time for Vacon 100 HVAC. The valid range is 0.0 to 6,553.4 sec (0.1 sec).

nciDrvSpeedScale

This configuration property is used as the default value for nviDrvSpeedScale. This value will be adopted at power-up and in case no input variable within the specified Receive Heartbeat time is received.

7. FAULT TRACING

When an unusual operating condition is detected by the AC drive control diagnostics, the drive initiates a notification visible, for example, on the keypad. The keypad will show the ordinal number of the fault, the fault code and a short fault description.

The fault can be reset with the Reset button on the control keypad or via the I/O terminal. The faults are stored in the Fault history menu which can be browsed. The different fault codes you will find in the table below. This fault table presents only the faults related to the fieldbus in use.

The LonWorks option board status LEDs are described in more detail in Chapter 4.1.2

NOTE: When contacting distributor or factory because of a fault condition, always write down all texts and codes on the keypad display and send a description of the problem together with the *Drive Info File* to fieldbus@vacon.com.

7.1 TYPICAL FAULT CONDITIONS

Fault condition	Possible cause	Remedy
Termination resistor	Missing or excessive termination resistor.	Install termination resistors at both ends of the fieldbus line.
Cabling	<ul style="list-style-type: none"> Supply or motor cables are located too close to the fieldbus cable Wrong type of fieldbus cable Too long cabling 	
Grounding	Inadequate grounding.	Ensure grounding in all points on the net
Connections	Faulty connections. <ul style="list-style-type: none"> Excessive stripping of cables Conductors in wrong terminals Too loose connections of conductors 	
Parameter	<ul style="list-style-type: none"> Faulty address Overlapping slave addresses Wrong baud rate Wrong control place selected 	

Table 15. Typical fault conditions

If you need to contact Vacon service in problems related to LonWorks, please send a description of the problem together with the *Drive Info File* to fieldbus@vacon.com.

8. QUICK SETUP

Frequency converter application

Choose Fieldbus (Bus/Comm) for the active control place (see Chapter 5.1).

Master software

1 = Write 100.0 1 to nviDrvSpeedStpt.

2 = Frequency converter status is RUN and output frequency is $1.00 * nviDrvSpeedScale$

3 = Write 0.0 0 to nviDrvSpeedStpt

4 = Frequency converter status is STOP.

If nvoDrvStats bit 3 = 1 Status of frequency converter is FAULT.

VACON

DRIVEN BY DRIVES

Find your nearest Vacon office
on the Internet at:

www.vacon.com



DPD00169