





**INDEX**

Document code: DPD01614A  
Date: 1.7.2014

1.	CONTENTS OF THE DELIVERY.....	2
2.	INSTALLATION .....	3
2.1	Optic fibre cable, signal listing and connections .....	5
2.2	Cable bushing diameters .....	6

## 1. CONTENTS OF THE DELIVERY

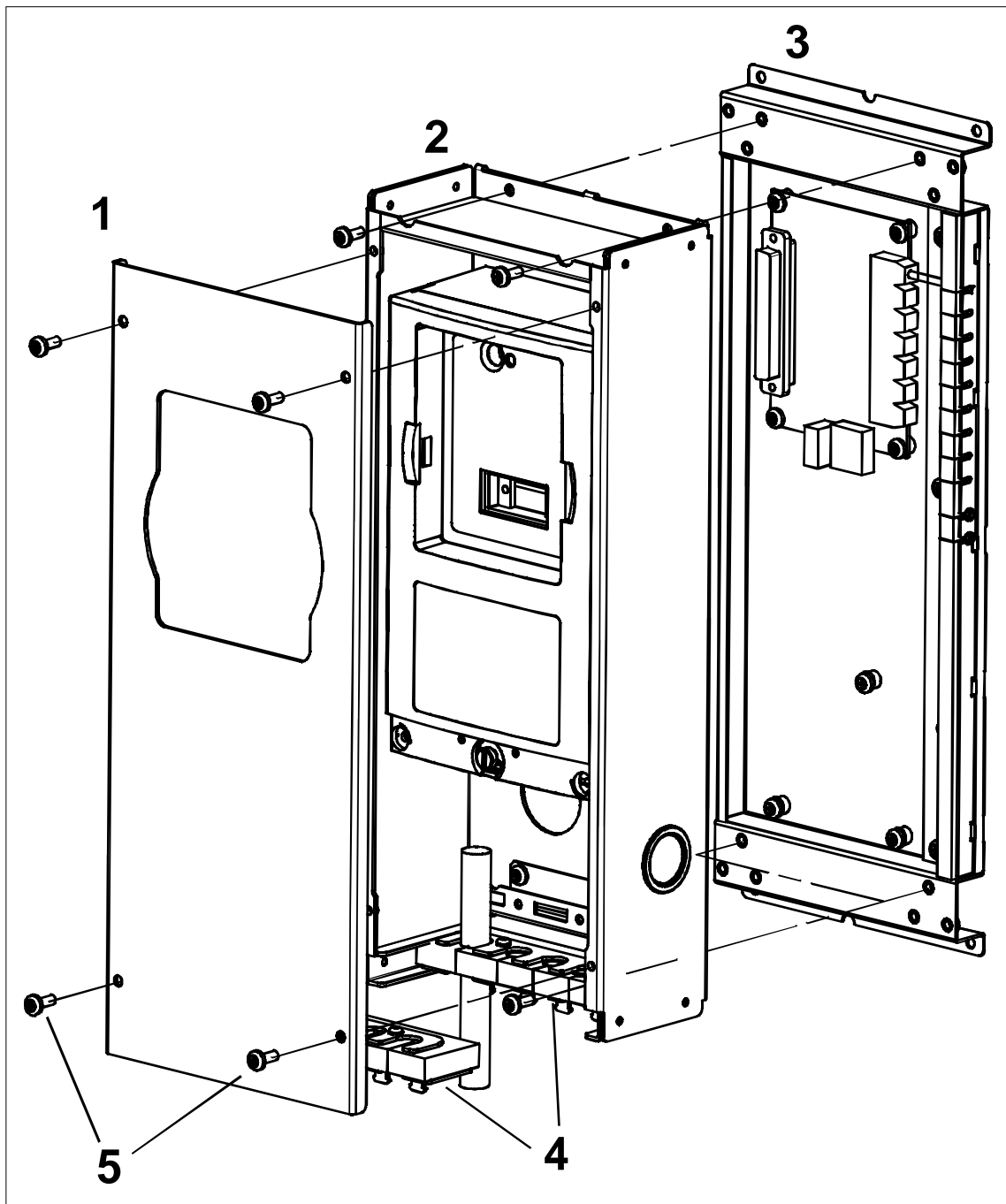

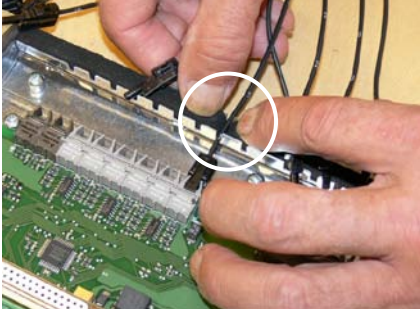





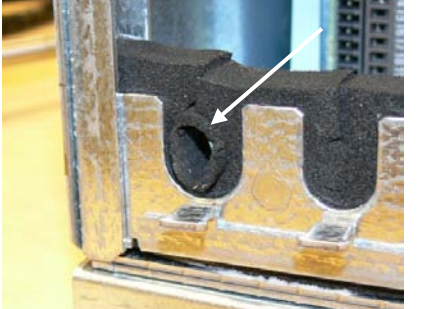

Figure 1. Contents of the IP 54 control box delivery

- |   |                                 |   |              |
|---|---------------------------------|---|--------------|
| 1 | IP54 control box                | 5 | Plastic pins |
| 2 | IP54 cable entry grommet plates |   |              |
| 3 | Grease for the grommet plates   |   |              |
| 4 | Screws (4x10)                   |   |              |

## 2. INSTALLATION

These instructions guide you through the installation of the IP54 control box that you have purchased for your FR12, FR14, F112, F114, CH64 or CH74 size frequency converter.

 <p>1. IP54 control box bottom plate with starcoupler board</p>	 <p>2. Connect the fibre optic cables. Push carefully the cables into the cellfoam bushings</p>	 <p>3. Each fibre optic cable has a number 1...8 and 11...18 marked on the cable shield at both cable ends. Connect each cable to the connectors marked with the same number on the starcoupler board. The list of the optic signals can be found in chapter 2.1</p>
 <p>4. Connect the 24 V cable and lead it through the bushing as shown in the figure.</p>	 <p>5. Close the cover by pushing it carefully down so that the D-connector connects thoroughly.</p>	 <p>6. Attach the cover with four screws (tightening torque 1,5 nm)</p>
 <p>7. Apply a thin layer of grease to the cellfoam washers</p>	 <p>8. Push the cellfoam washer into the guides in the enclosure.</p>	 <p>9. Open the bushing for the cable. Pull away the right size of piece according to the cable size (in this figure 8 mm).</p>

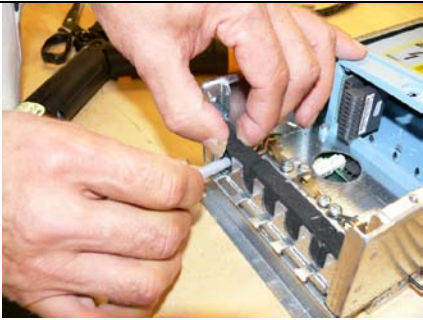

10. Push the cable to the bushing. Make sure that the cellfoam surrounds the cable tightly.

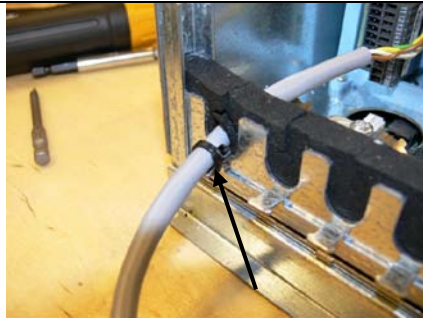

11. Attach the cable to the washer with a plastic binder

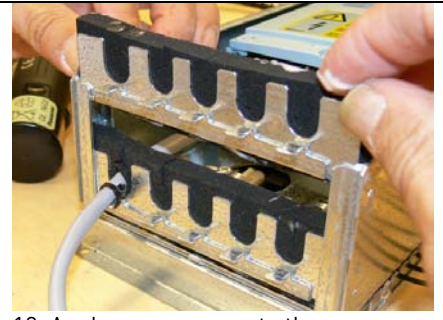

12. Apply some grease to the upper cellfoam washer and push it to its place.



13. Attach the seal around the RS485 connector.

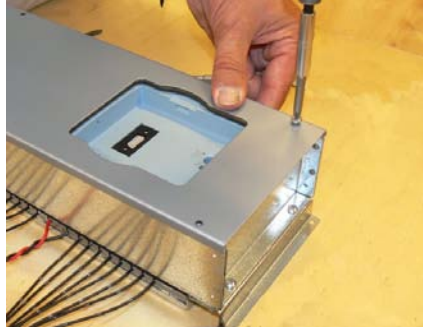

14. Attach the cover plate with four screws

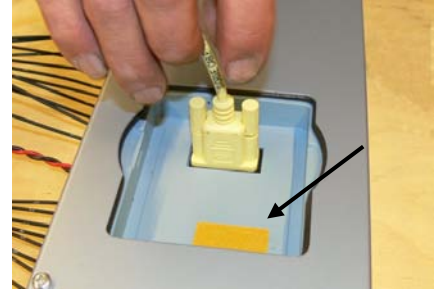

15. Seal the holes with a piece of tape and attach the RS485 cable

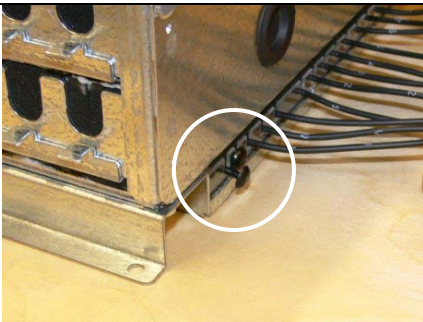

16. Push the plastic pins to the unused cable entries .



2.1 Optic fibre cable, signal listing and connections

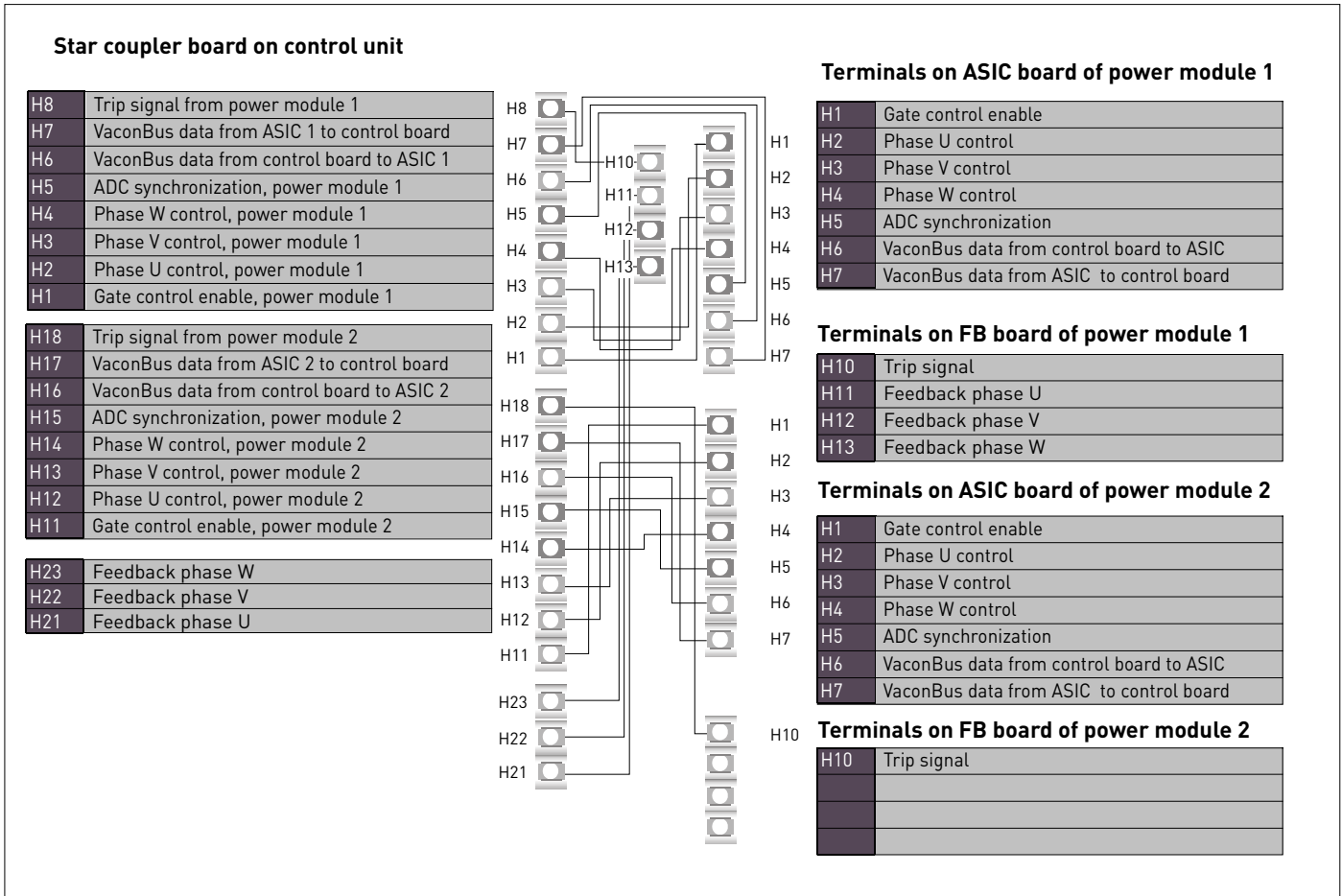
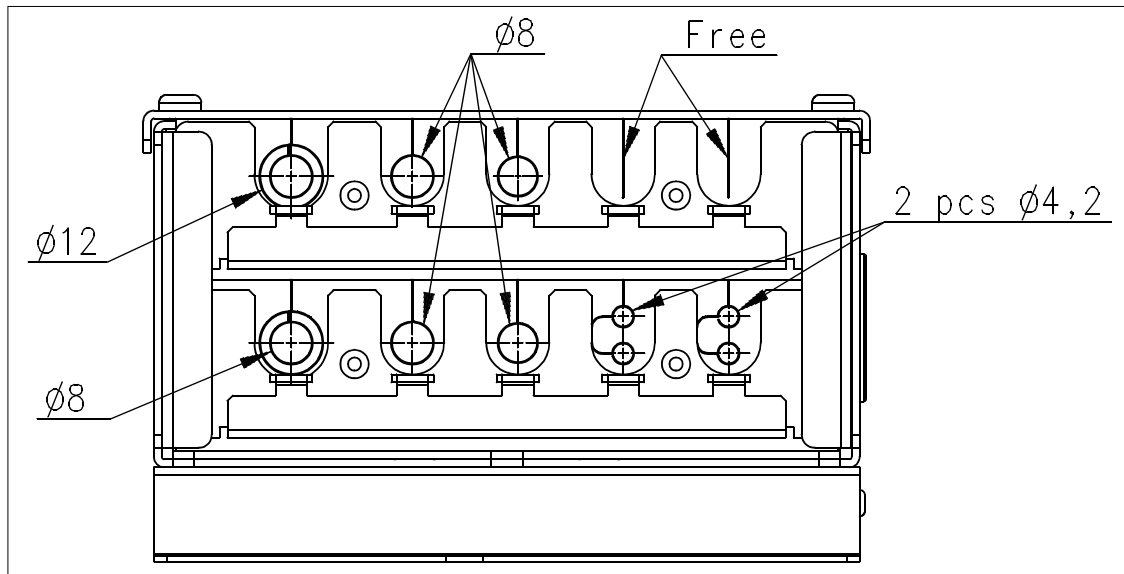

Figure 2. Internal fibre cable connections

## 2.2 Cable bushing diameters

Figure 3. Cable bushing diameter







# VACON<sup>®</sup>

**DRIVEN BY DRIVES**

Find your nearest Vacon office  
on the Internet at:

[www.vacon.com](http://www.vacon.com)

Manual authoring:  
[documentation@vacon.com](mailto:documentation@vacon.com)

Vacon Plc.  
Runsorintie 7  
65380 Vaasa  
Finland

Subject to change without prior notice  
© 2014 Vacon Plc.

Document ID:



Rev. A

Sales code: DOC-INSIP54BOX+DLUK