

VACON[®] NXS/P
AC DRIVES

**FLANGE MOUNTING KIT
FOR FR7-FR9
INSTALLATION MANUAL**

VACON[®]

Document code: DPD01880A
Date: 5/12/2016

INDEX

1.	General	3
2.	Vacon Flange Mounting Kit contents.....	4
3.	Installation.....	6
3.1	FR7	6
3.2	FR8	8
3.3	FR9	9
4.	Mounting.....	10
5.	Information sticker	11

1. GENERAL

Using the Vacon Flange Mounting Kit, you can mount your Vacon NX frequency converter through the cabinet wall so that the control unit of the drive remains inside the cabinet.

The correct installation of the Flange Mounting Kit affects the IP protection class of the frequency converter. After the installation, the control unit is protected according to IP21 and the power unit according to IP54 (unless the frequency converter was originally IP21-protected). See figure below.

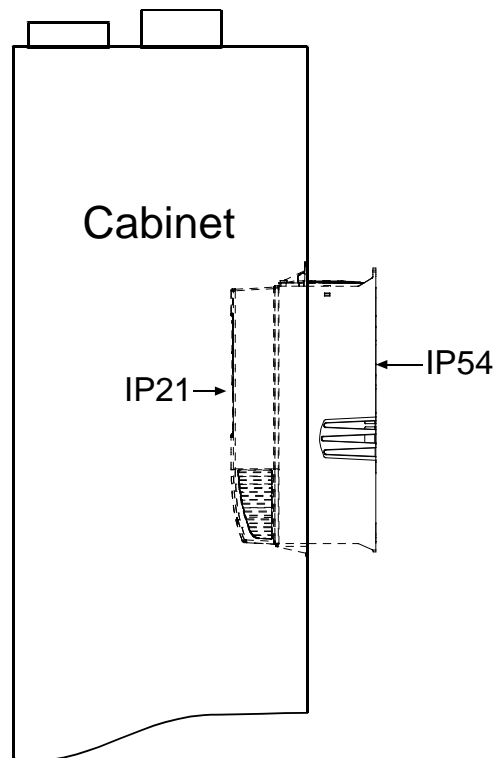

According to standard IEC 60529 (EN 60529), the IP54 frequency converter enclosure provides protection against dust and water sprayed from all directions. Limited ingress of both is permitted.

2. VACON FLANGE MOUNTING KIT CONTENTS

The contents of the Flange Mounting Kits for different frames are shown in the following pictures.

FR7:

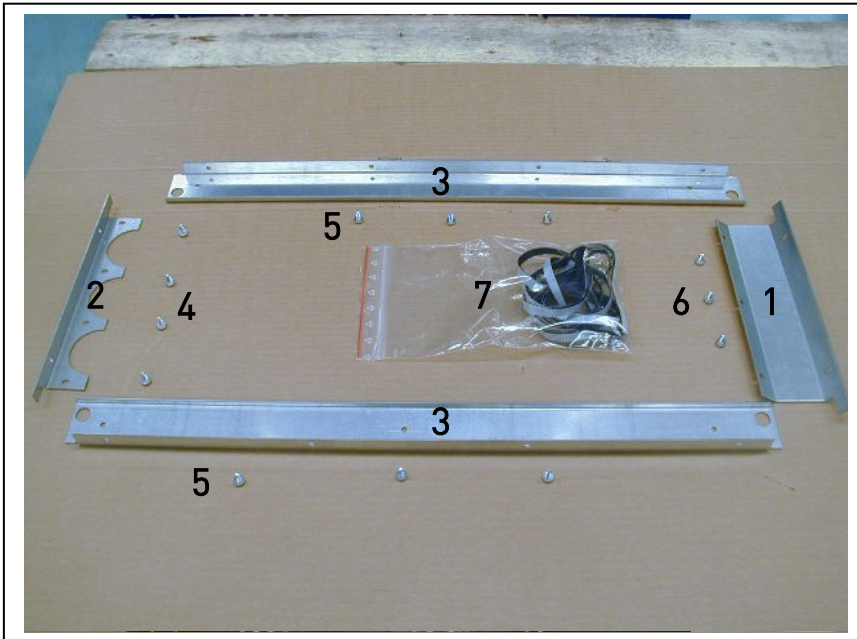

- | | | | |
|---|----------------|---|------------------|
| 1 | Flange, top | 4 | Screws (5*10 TF) |
| 2 | Flange, bottom | 5 | Screws (5*10 TX) |
| 3 | Flange, side | 6 | Screws (5*8 TX) |
| | | 7 | Sealing tape |

FR8:



- 1 Flange, top
- 2 Flange, bottom
- 3 Flange, side
- 4 Screws (4*8)
- 5 Sealing tape

FR9:

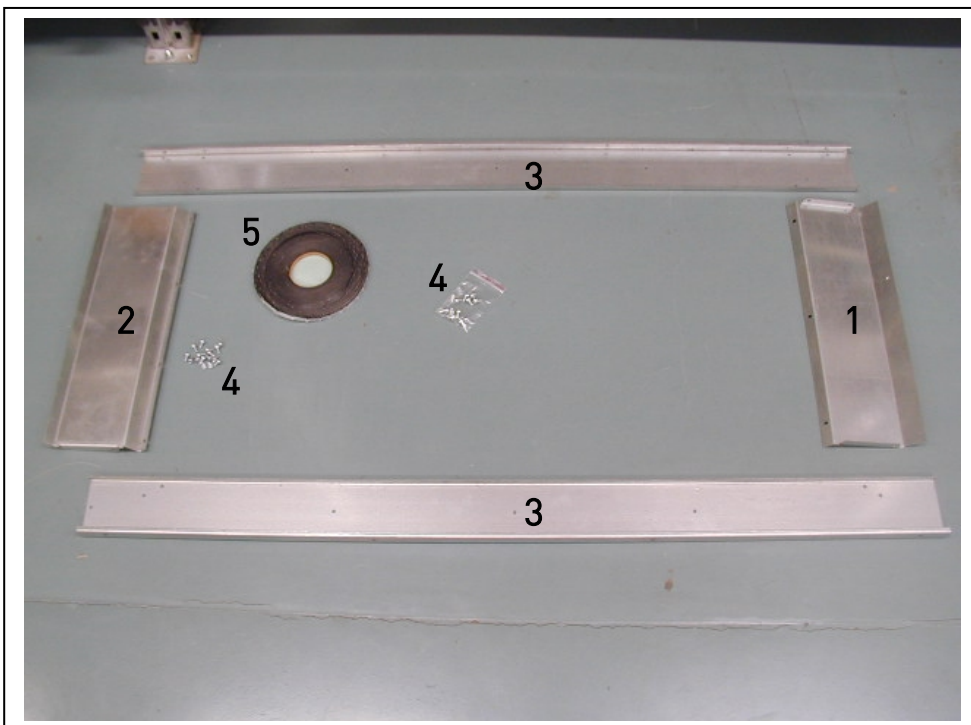









- 1 Flange, top
- 2 Flange, bottom
- 3 Flange, side
- 4 Screws (6*10)
- 5 Sealing tape

3. INSTALLATION

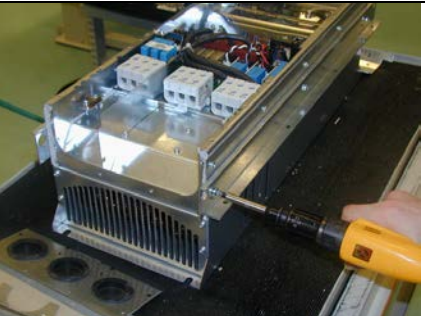
These instructions guide you through the installation of the Flange Mounting Kit that you have purchased for your FR7, FR8 or FR9 size frequency converter.

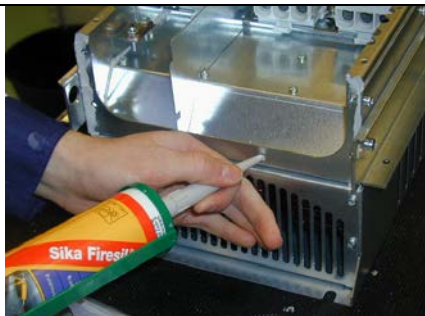
Note: The sealant to be used in the flange mounting kit installation is flame retardant silicone sealant (e.g. Sika Firesil -N)

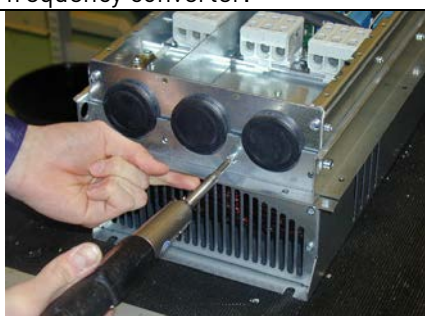
3.1 FR7

		
<p>1. Remove the three screws from both sides of the frequency converter.</p>	<p>2. Remove also three screws from the top of the frequency converter</p>	<p>3. Attach the side flange to both sides with 5x10 Torx screws</p>
		
<p>4. Attach the top flange with three 5x8 Torx screws.</p>	<p>5. Seal the two holes and the sides in the bottom of the frequency converter.</p>	<p>6. Fix the cable entry flange to its place. Attach first the screws (5x10 TF) in the upper corners.</p>
		
<p>7. Seal the bottom flange.</p>	<p>8. Attach the bottom flange. Fasten first only the two screws (5x10 TF) in the middle</p>	<p>9. Seal the sides of the cable entry flange. Then attach the two remaining screws (5x10 TF).</p>



7. Seal the sides of the frequency converter.

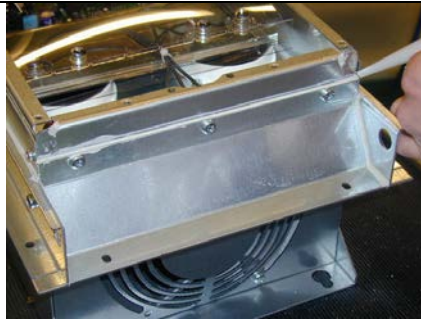

8. Seal the top flange.

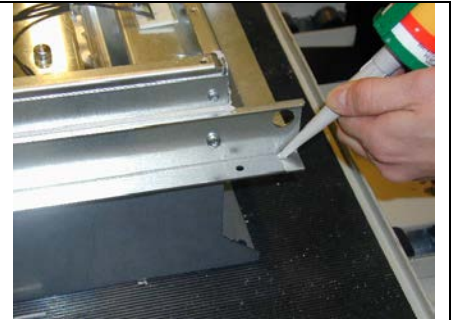







9. Seal the small seams in each corner.

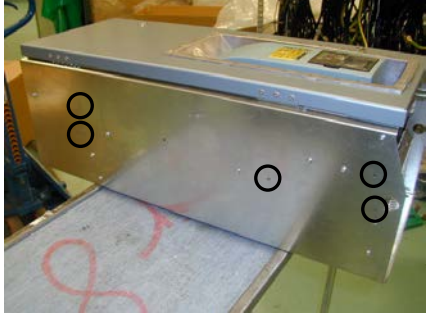

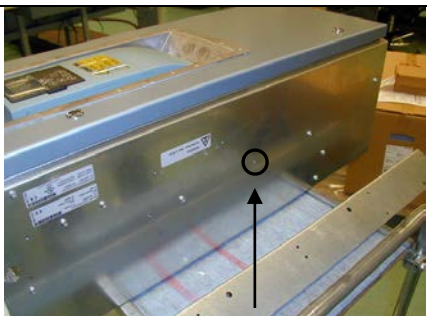
10. Smoothen all sealed seams with your finger. Tip your finger in soap water before smoothening the seams.

3.2 FR8

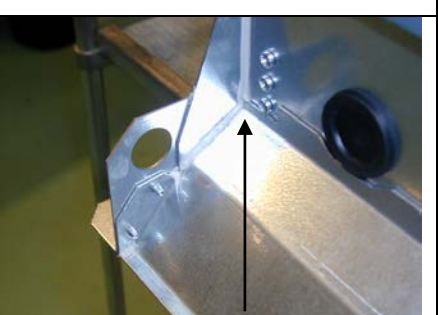
		
<p>1. Remove these five screws from the right side of the frequency converter.</p>	<p>2. Apply sealant to the right side flange.</p>	<p>3. Attach the right side flange with five screws (4x8 TF).</p>
		
<p>4. Repeat the steps 1-3 with the left side flange. Remove also the middle screw from this side.</p>	<p>5. Seal the bottom flange with sealing tape and attach it with four screws (4x8 TF).</p>	<p>6. Seal the top flange with sealant.</p>
		
<p>7. Attach the top flange with five screws (4x8 TF). See also the next picture.</p>	<p>8. Seal all seams of the top and bottom flanges with sealant.</p>	<p>8. Seal all seams of the top and bottom flanges with sealant.</p>

3.3 FR9

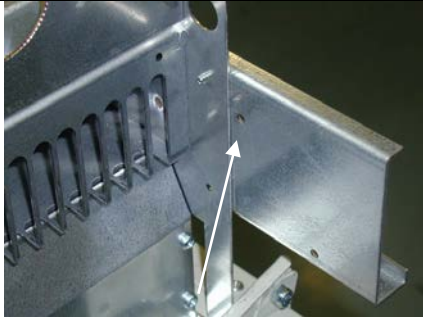

1. Before attaching the side flanges check that they are in the correct order. If the inner hole is not showing the flange is on the wrong side.

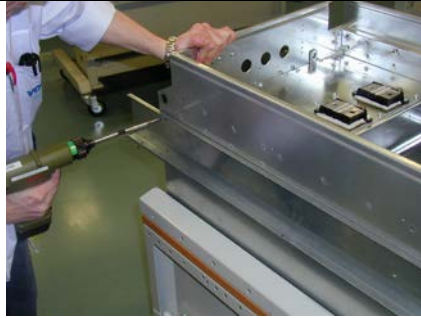

2. Seal the side flanges with sealant and attach them with 7 (6x10 TF) screws each.



3. Seal the top flange with sealant and fasten it with four screws (6x10 TF).



4. Fasten the sides of the top flange with two screws/side (6x10 TF).



5. Carefully seal all the seams of the top flange with sealant.



6. Seal the bottom flange with sealant and attach it four screws (6x10 TF).



7. Fasten the sides of the bottom flange with two screws/side (6x10 TF). Seal all seams as shown in step 5.

4. MOUNTING

MOUNTING PROCEDURE

1. Make an opening in the cabinet door for the flange (collar) installation using the dimensions given in Vacon NX User's manual, chapter 5.
2. Attach the sealing tape around the opening. See Figure 1 for how to bend the tape at the corners of the opening (1) and place the tape so that it runs *inside* the screws (2). The kit contains a greater amount of tape than what you might need. Only use such an amount of tape required by the dimensions of the opening.
3. Fit the frequency converter in the opening.
NOTE: The frequency converter will not fit in the opening in a straight position. Tip the converter positioning the lower end first in the opening. See Figures 4 and 5.

Fix the converter on the plane with the screws attached.

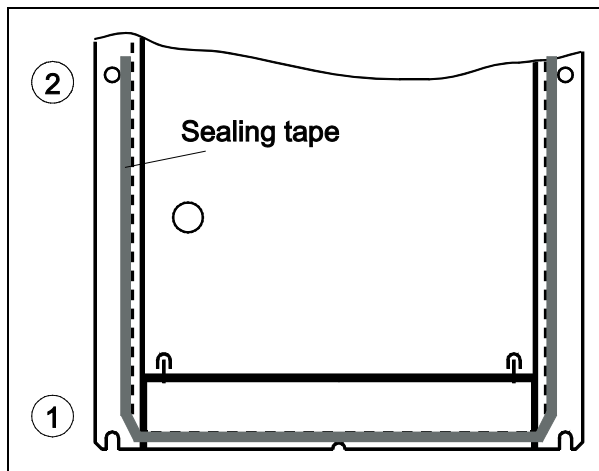
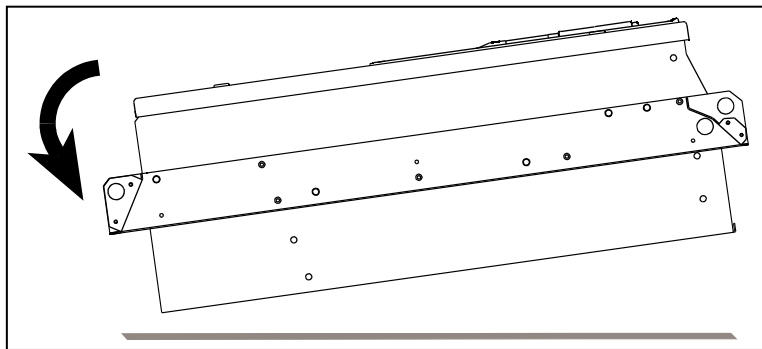
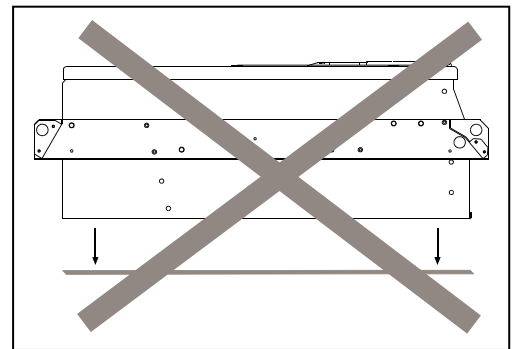

Figure 1



Figures 4 and 5.



5. INFORMATION STICKER

Each Flange Mounting Kit delivered by the factory includes a sticker (shown below). Please check *IP54/Collar* (1) and mark the installation date (2) on the sticker. Finally, attach the sticker on the drive.

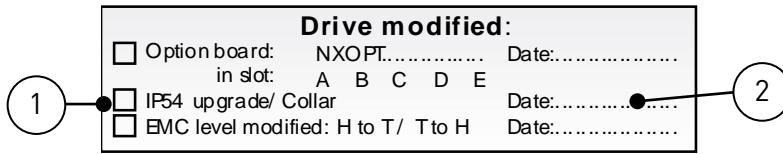

VACON®

www.danfoss.com

Vacon Ltd
Member of the Danfoss Group
Runsorintie 7
65380 Vaasa
Finland

Document ID:



Rev. A