

LINEATOR™ Advanced Universal Harmonic Filter



The LINEATOR Advanced Universal Harmonic Filter (AUHF) is a revolutionary advancement in the area of passive harmonic mitigation. No other device on the market can meet the stringent limits of IEEE Std 519 at an equivalent efficiency, size and cost.

When your application calls for a truly cost effective harmonic solution, the LINEATOR AUHF is the logical choice. It provides Engineers with a standard off-the-shelf solution for what used to be a very challenging engineering problem.

As industry evolves, so does the Lineator. Mirus has expanded its product line to include two new Lineator models to meet your needs for those demanding applications.

Revolutionary Reactor Design

Better than 18-Pulse performance from standard 6-Pulse Variable Speed Drives

Up to 3% more energy efficient than 18-Pulse or Active Front-end solutions and every bit as effective in treating harmonics

Will meet IEEE 519 Std for both current and voltage distortion

ABS Type Approved for marine applications

'Wide Spectrum Harmonic Filter' that treats all harmonics generated by 3-phase diode or thyristor bridge rectifiers

Lineator-HP™ High Performance model used where the highest power quality demands must be met

Once again MIRUS leads the way in innovative passive harmonic mitigation solutions with the introduction of its new LINEATOR-HP™ model which is designed to offer <5%, THD(I). This level of harmonic mitigation matches Active Front end Drives (AFE'S) and Active Filter (AF) performance without the high frequency harmonics introduced by these more expensive and complex solutions. With the addition of a new reactor design that allows for onsite reactor impedance optimization, current distortion levels of <5% THD(I) are achieved without introducing excessive voltage drop or VSD instability.

Lineator-ED™ Extreme Duty model used when the operating conditions and environments can be harsh

For extreme environments, such as excessive background voltage distortion (5% to 12% VTHD), high ambient (up to 55° C) or high elevation (above 3000 ft), Mirus now offers an extreme duty model for its Lineator AUHF. Our standard Lineator AUHF already outperforms any other competitive filter by guaranteeing performance when background voltage distortion is as high as 5%. In some applications however, such as marine vessels, drilling rigs and oil fields equipped with electrical submersible pumps (ESP's), existing voltage distortion levels will often exceed 5%. Also, when ambient temperature levels exceed 40° C or at higher elevations where the air is thinner, a more robust filter is required. The Lineator-ED model will meet this challenge.



Design Considerations for Meeting Harmonic Limits in Variable Speed Drive Applications

Features

- The most energy efficient harmonic solution for VSD's
- Meets harmonic limits for both land and marine VSD applications
- Guaranteed to meet IEEE Std 519 for both current and voltage distortion at the input terminals of the LINEATOR and PCC
- Wide Spectrum Harmonic Filter treats all major harmonics generated by VSD's and other 3-phase rectifier loads
- Total Demand Distortion (TDD) of the current at the LINEATOR input terminals will not exceed the limits as defined in Table 10.3 of IEEE Std 519
- Compatible with engine driven generators thanks to the extremely low capacitive reactance, even at no load
- Suppresses overvoltages caused by commutation notching, capacitor switching and other fast changing loads
- Suitable for application on multiple VSD's provided only VSD's are connected
- Models available for AC Drives and DC Drives or other controlled rectifiers

The LINEATOR is a purely passive device consisting of a unique inductor combined with a relatively small capacitor bank. Its innovative design achieves reduction of all the major harmonic currents generated by VSD's and other similar 3-phase, 6-pulse rectifier loads. The resulting ITHD is reduced to <8% and is now available in a model that achieves <5%. Although referred to as a filter, the LINEATOR exhibits none of the problems that plague conventional filters.

Harmonic Distortion Reduction

The filtering effectiveness of a trap filter is dependent upon the amount of harmonics present at untuned frequencies as well as the residual at the tuned frequency. To obtain performance better than 15% ITHD, multiple tuned branches are often required. Other broadband filters require relatively large capacitor banks (*2 to 3 times more than Lineator*) to achieve reasonable performance.

Harmonics from other sources

As a parallel connected device, the conventional trap filter has no directional properties. It therefore, can easily be overloaded by attracting harmonics from upstream non-linear loads. The LINEATOR, on the other hand, will present a high impedance to line side harmonics eliminating the possibility of inadvertent importation and overloading.

System Resonance

At frequencies below its tuned frequency, a conventional filter will appear capacitive. This capacitance has the potential of resonating with the power systems natural inductance. When a filter is tuned to a higher order harmonic, such as the 11th, it could easily resonate at a lower harmonic frequency, such as the 5th or 7th. Even the LCL passive filters required for low harmonic AFE Drives or parallel Active Harmonic Filters are susceptible to this problem. The natural resonance frequency of the LINEATOR is below that of any predominant harmonic, therefore inadvertent resonance is avoided.

Capacitive Reactance and Leading Power Factor

The large capacitor banks in trap filters and competing broadband filters present a high capacitive reactance to the system, especially under light loads. On weak power systems, this can raise voltages or cause excitation control problems in generator applications. To address this, some filter manufacturers offer mechanisms for switching out the capacitors under light loads, increasing cost and complexity. This is not necessary for the LINEATOR because even under no load conditions, its capacitive reactance (kVAR) remains below 15% of its kVA rating. This ensures compatibility with engine generators, without the need to switch out capacitors.

Benefits

- Saves energy by reducing upstream harmonic losses while operating at >99% efficiency
- Will not resonate with other power system components or attract line side harmonics
- Frees up system capacity by restoring VSD to near unity power factor
- Removal of harmonics improves overall system power factor
- True Power factor > 0.95 from 30% to 100% load
- Low capacitive reactance ensures generator compatibility
- Low capacitive reactance also eliminates the need for capacitor switching contactors (contactors are available upon request)

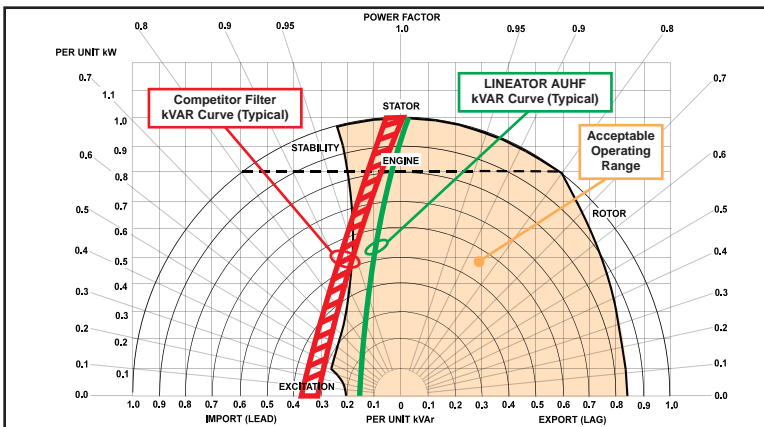

Generator Reactive Power Capability Curve

Compare Performance!

The LINEATOR outperforms all other forms of VSD harmonic solutions. By choosing the LINEATOR you have selected a filter that:

- performs in Real World environments even with background voltage distortion and voltage imbalance
- lowers operating costs by being highly efficient
- is compatible with engine generators and incorporates a low capacitive reactance design
- has a simple and compact design to reduce footprint and ensure reliability
- can be computer modeled to provide up front assurance of meeting harmonic limit standards such as IEEE Std 519, ABS and other marine certifying bodies
- is factory performance tested under actual VSD loading

Outperforms 18-P Solutions

As background voltage distortion increases, the harmonic mitigating performance of the 18-Pulse VSD degrades much quicker than the 6-Pulse / LINEATOR combination. This demonstrates that the LINEATOR AUHF will not attract harmonic currents as other non-linear loads distort the applied voltage waveform. LINEATOR is the only harmonic solution that guarantees performance even in heavily distorted environments.

There is little degradation in harmonic mitigating performance of the 6-Pulse / LINEATOR combination as voltage imbalance increases. The 18-Pulse solution, on the other hand, degrades dramatically because harmonic cancellation due to phase shifting becomes much less effective with 3-phase voltage imbalance.

The 6-Pulse VSD / LINEATOR combination has 2% to 3% higher efficiency than the 18-Pulse solution over the entire operating range. (Efficiency shown is for a system that includes motor/gen set load, VSD, and harmonic mitigation equipment). When compared to an 18-Pulse VSD, a 400HP AUHF/VSD will save more than \$3,000 in annual operating costs when averaging 75% loading at \$0.07/kWhr.

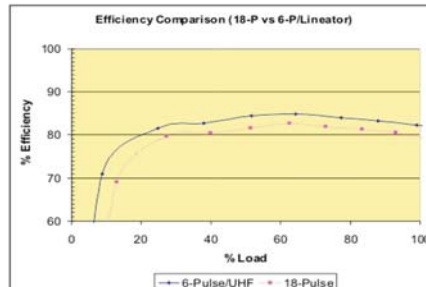
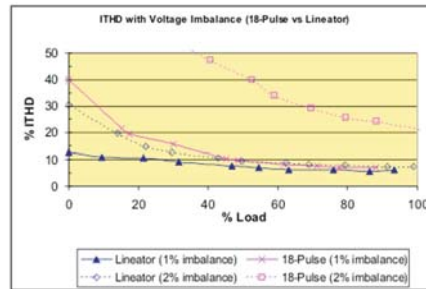
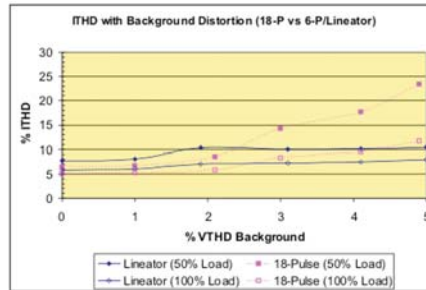

Efficiency Comparison

The unique design of the AUHF produces extremely low losses. It's operating efficiency therefore is much higher than competitive filters. The graphs below show typical losses and efficiencies for AUHF and two competitors. (AUHF is available in sizes up to 3500HP. Since competitor maximum sizes are only 600HP and 900HP, the chart range has been set at 1000HP)

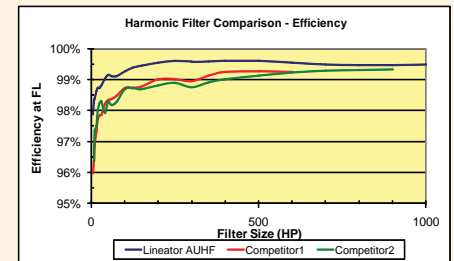
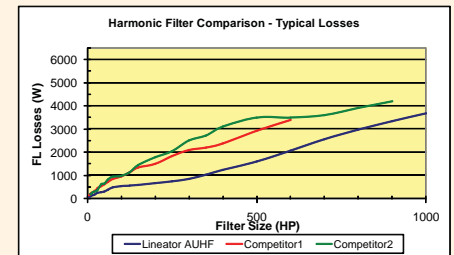

Improves VSD Performance

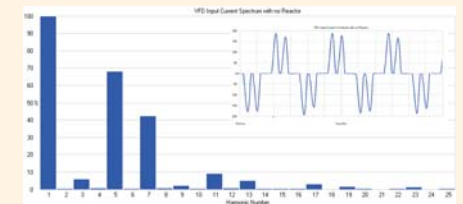

VSD Input Current Waveform and Spectrum with no reactor.



VSD Input Current Waveform and Spectrum with AC reactor.

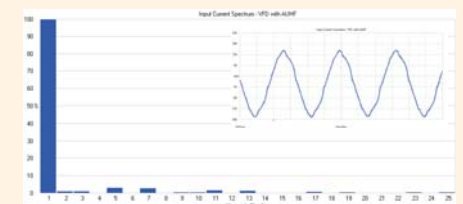

VSD Input Current Waveform and Spectrum with LINEATOR AUHF.

'Performance Guarantee'

MIRUS guarantees that the LINEATOR AUHF will perform as advertised to reduce harmonic distortion caused by AC Variable Speed Drives and other non-linear loads equipped with 3-phase, 6-pulse, diode bridge rectifiers. A properly selected and installed LINEATOR will:

Reduce Current Total Harmonic Distortion (ITHD), measured at the LINEATOR input terminals at full load, to:

- (i) <8% when background voltage distortion is <5% and voltage imbalance is <3%
- (ii) <5% when short circuit ratio (Isc/IL), as defined by IEEE Std 519, is <20 and when background voltage distortion is <0.5% and voltage imbalance is <1%
- (iii) Reduce Current Total Demand Distortion (ITDD), measured at the LINEATOR input terminals over its entire operating range, to levels defined in Item (i) above. ITDD is defined as the ratio of ITHD divided by the full load current (peak demand current) of the LINEATOR.
- (iv) Minimize the contribution to Voltage Harmonic Distortion of all VSD's equipped with the LINEATOR to <5% total and <3% for individual harmonics, as defined by IEEE Std 519-1992.
- (v) NOT become overloaded by other upstream harmonic sources.
- (vi) NOT resonate with other power system components.
- (vii) NOT have compatibility problems with engine generator sets properly sized for the load.



The Harmonics & Energy (H&E™) Lab

The Harmonics & Energy (H&E) Lab at MIRUS International Inc. provides the unique ability to test our products under 'real world' non-linear load conditions. We also conduct compatibility testing with all major VSD manufacturers' products to ensure a trouble-free installation.

Every LINEATOR is factory tested under VSD load to ensure our performance guarantee is met. No other manufacturer provides this level of testing whether they offer a passive filter, multi-pulse or active solution.



SOLV™ Harmonic Analysis Software

MIRUS offers proprietary software called Simulation of LINEATOR / VFD (SOLV). SOLV is a powerful and unique computer simulation program that will calculate current and voltage distortion levels based on your load requirements.

By simply entering some basic information about your source and VSD system, you can generate very useful reports such as, an IEEE 519 Compliance Report. In addition to the accurate reports, you can print a single line representation of your system along with voltage and current waveforms and spectrums.

MIRUS' SOLV will help you find the right solution for your VSD application without the need of a costly harmonic study. It can be downloaded at mirusinternational.com

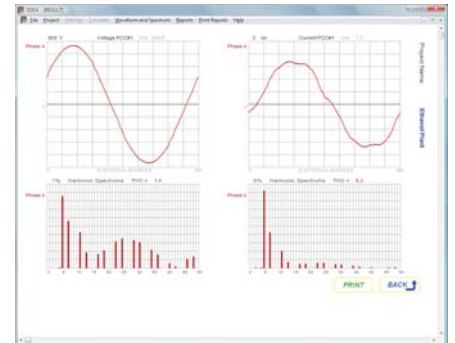
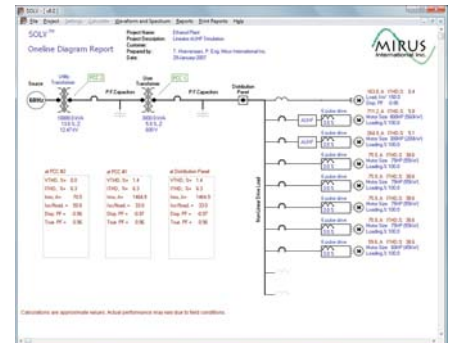

Lineator Applications

Oil & Gas Industry

Application of ASD's in the Oil and Gas Industry continues to grow at a rapid pace. This includes Electrical Submersible Pumps (ESP's), Top Drives and Mud Pumps on Drilling packages, Compressors, etc. Without harmonic mitigation, very serious consequences can result. Although not conclusively proven, high levels of harmonic distortion has been considered as a possible cause of off-shore drilling rig disasters in the Gulf of Mexico and the North Sea.

Water & Waste Water

Although 18-Pulse ASD's are commonly used in the Water and Waste Water applications, there is a much better solution available. Lineator paired with a 6-Pulse ASD provides better harmonic mitigation performance especially if the supply has even low levels of voltage imbalance. And the Lineator's much lower losses can result in thousands of dollars in energy savings annually.

HVAC Systems

In many commercial buildings, the chillers, pumps and fan systems required for cooling represent a very large component of the building's electrical load. For today's Green Building designs, ASD's are being used on all of this equipment leading to harmonic distortion issues. To address this concern, Lineators are being used to eliminate harmonics without sacrificing any of the energy savings advantages of the ASD.

Marine Vessels

Due to the serious consequences of high harmonic distortion, the American Bureau of Shipping (ABS), Det Norske Veritas (DnV) and all other Marine Certifying bodies have mandatory harmonic limits that must be met in order to attain certification. Since ASD's are now common-place on thrusters and main propulsion systems, these limits cannot be met without effective harmonic mitigation. The Lineator will meet these limits without introducing the troublesome high frequency harmonics associated with active solutions such as Active Front-end Drives and Active Harmonic Filters.

Condition Based Maintenance Tool

When InSight™ is integrated into your system it provides essential health and performance information to the operator to let them know whether the equipment is operating within safe limits. For instance, should power quality or environmental conditions affect the normal operation of an Adjustable Speed Drive equipped with a Lineator Harmonic Filter and InSight™ monitor, operators can be notified of the filter's condition so that proactive action can be taken, if necessary.

Apply LINEATOR anywhere
Variable Speed Drives and
6-Pulse Rectifiers are used



- Oil and Gas industry
- Water and Waste Water
- Irrigation systems
- HVAC systems
- Mining operations
- Marine vessels
- Printing presses
- Elevators and escalators
- Pulp and paper processing
- Induction furnaces
- Industrial rectifiers
- Welding operations

Stay in touch with your
equipment, locally or
remotely



Mirus designed InSight™ as a web-based monitoring system allowing easy access via any web browser or by adding a touchscreen display at the equipment.



Rating Tables: (type 'D' Lineator)^[1]

Specifying the LINEATOR HP for applications with standard 6-Pulse VFD's provides end-users with low harmonic drive systems that results in 20% to 30% less capital costs than other solutions



Motor Size		Lineator Rating (3-Phase)					208, 240V (60Hz)				400, 440V (50Hz)				
HP	kW	Input Amps				Output kW	Standard Enclosure		Enhanced Enclosure		Standard Enclosure		Enhanced Enclosure		
		208V 60Hz	220/240V 50/60Hz	380/400V 50Hz	415/440V 50Hz		Case Style	Weight lbs [kg] ^[1]	Case Style	Weight lbs [kg] ^[1]	Case Style	Weight lbs [kg] ^[1]	Case Style	Weight lbs [kg] ^[1]	
5	4	14	13	8	7	4.5	SU1	65 [30]	75 [34]	SU1-E	58 [26]	SU1	67 [30]	SU1-E	68 [31]
7.5	5.5	20	18	11	10	6.3									
10	7.5	27	24	14	13	8.5	80 [36]	80 [36]	78 [35]	88 [40]					
15	11	40	36	21	19	13	117 [53]	127 [58]	90 [41]	100 [45]					
20	15	53	48	28	25	17	138 [63]	148 [67]	118 [54]	128 [58]					
25	18.5	66	60	35	32	21	154 [70]	164 [74]	130 [59]	140 [64]					
30	22	79	72	42	38	25	189 [86]	199 [90]	142 [65]	152 [69]					
40	30	105	95	55	51	34	253 [115]	263 [119]	154 [70]	164 [74]					
50	37.5	131	119	69	63	42	275 [125]	333 [151]	186 [84]	196 [88]					
60	45	158	143	83	76	51	315 [143]	337 [153]	218 [99]	228 [103]					
75	55	196	178	103	95	63	325 [148]	399 [181]	304 [138]	314 [142]					
100	75	260	236	137	125	84	442 [201]	516 [235]	323 [147]	414 [188]					
125	90	323	294	170	156	104	468 [213]	542 [246]	345 [156]	434 [197]					
150	110	388	353	204	187	125	553 [251]	627 [285]	365 [166]	469 [213]					
200	150			274	250	168			415 [189]	514 [234]					
250	185			340	312	209			578 [262]	600 [273]					
300	200			410	374	251			585 [266]	670 [305]					
350	250			475	436	292			800 [363]	1006 [456]					
400	315			565	520	349			825 [374]	1031 [467]					
500	400			720	660	443			915 [415]	1121 [508]					
600	450			810	740	499			1098 [499]	1176 [535]					
700	500			940	865	579			1700 [771]	1839 [834]					
800	560			1075	985	662			1882 [854]	1954 [886]					
900	630			1200	1100	736			1920 [871]	2054 [931]					
1000	710			1335	1220	818			1950 [884]	2084 [945]					
1100	800			1470	1340	900			2465 [1118]	2564 [1163]					
1200	900			1610	1470	987			2568 [1167]	2958 [1245]					
1300	970			1735	1585	1064			2718 [1236]	3408 [1549]					
1400	1000			1870	1710	1145			2858 [1299]	3548 [1613]					
1500	1120			2000	1835	1228			3598 [1635]	3690 [1677]					
1600	1200			2145	1965	1316			3748 [1703]	3840 [1745]					
1800	1350			2410	2210	1481			3848 [1749]	4376 [1943]					
2000	1450			2670	2440	1636			3978 [1808]	4506 [2048]					
2300	1700			3065	2810	1882			4075 [1850]	4600 [2088]					
2500	1850			3335	3050	2045			4650 [2111]	4750 [2157]					
2800	2100			3750	3435	2303			5000 [2270]	5100 [2315]					
3000	2250			4020	3680	2468			5225 [2372]						
3500	2600			4265	3905	2618			5550 [2520]						



Motor Size		Lineator Rating (3-Phase)					480V (60Hz)				600V (60Hz), 690V (50-60Hz)			
HP	kW	Input Amps				Output kW	Standard Enclosure		Enhanced Enclosure		Standard Enclosure		Enhanced Enclosure	
		460/480V 60Hz	575/600V 60Hz	660/690V 50/60Hz	Output kW		Case Style	Weight lbs [kg] ^[1]	Case Style	Weight lbs [kg] ^[1]	Case Style	Weight lbs [kg] ^[1]	Case Style	Weight lbs [kg] ^[1]
5	4	7	5	5	4.5	SU1	58 [26]	SU1-E	68 [31]	SU1	57 [26]	SU1-E	67 [30]	
7.5	5.5	9	7	6	6.3									67 [30]
10	7.5	12	10	8	8.5	78 [35]	88 [40]	77 [35]	87 [39]					
15	11	17	14	12	13	90 [41]	100 [45]	86 [39]	96 [44]					
20	15	23	18	16	17	118 [54]	128 [58]	98 [45]	128 [58]					
25	18.5	29	23	20	21	130 [59]	130 [59]	125 [57]	135 [61]					
30	22	34	28	24	25	142 [65]	152 [69]	137 [62]	147 [67]					
40	30	46	37	32	34	154 [70]	164 [74]	149 [68]	159 [72]					
50	37.5	57	45	40	42	186 [84]	196 [89]	184 [83]	196 [89]					
60	45	69	55	48	51	218 [99]	228 [103]	206 [94]	216 [98]					
75	55	85	68	59	63	304 [138]	314 [142]	298 [135]	308 [140]					
100	75	113	90	79	84	323 [147]	333 [151]	315 [143]	325 [147]					
125	90	141	112	98	104	345 [156]	419 [191]	345 [156]	419 [191]					
150	110	169	135	118	125	365 [166]	439 [200]	365 [166]	439 [200]					
200	150	226	180	158	168	415 [189]	489 [222]	415 [189]	489 [222]					
250	185	281	225	196	209	578 [262]	640 [290]	578 [262]	640 [290]					
300	200	337	270	235	251	585 [266]	695 [316]	585 [266]	695 [316]					
350	250	395	315	275	292	800 [363]	1006 [456]	780 [354]	1006 [456]					
400	315	470	375	325	349	825 [374]	1031 [467]	805 [365]	1031 [467]					
500	400	595	475	415	443	915 [415]	1121 [508]	915 [415]	1121 [510]					
600	450	670	535	470	499	1398 [634]	1476 [670]	1398 [634]	1476 [670]					
700	500	780	625	545	579	1700 [771]	1839 [834]	1650 [748]	1740 [789]					
800	560	890	715	620	662	1882 [854]	1954 [886]	1805 [819]	1852 [842]					
900	630	990	795	690	736	1920 [871]	2054 [931]	1882 [854]	2054 [932]					
1000	710	1100	880	770	818	1950 [884]	2084 [945]	1915 [869]	2064 [936]					
1100	800	1210	970	845	900	2465 [1118]	2564 [1163]	2331 [1057]	2515 [1141]					
1200	900	1330	1060	925	987	2568 [1167]	2958 [1245]	2465 [1121]	2855 [1298]					
1300	970	1430	1145	1000	1064	2718 [1236]	3408 [1549]	2609 [1186]	2999 [1363]					
1400	1000	1540	1235	1075	1145	2858 [1299]	3548 [1613]	2782 [1265]	3172 [1442]					
1500	1120	1650	1325	1155	1228	3598 [1635]	3690 [1677]	3540 [1606]	3620 [1642]					
1600	1200	1770	1415	1235	1316	3748 [1703]	3840 [1745]	3702 [1679]	3800 [1724]					
1800	1350	1990	1595	1390	1481	3848 [1749]	4376 [1943]	3798 [1723]	3875 [1758]					
2000	1450	2200	1765	1535	1636	3978 [1808]	4506 [2048]	3945 [1789]	4250 [1928]					
2300	1700	2530	2030	1765	1882	4075 [1850]	4600 [2088]	4015 [1821]	4340 [1969]					
2500	1850	2755	2205	1920	2045	4650 [2111]	4750 [2157]	4600 [2087]	4750 [2155]					
2800	2100	3100	2480	2160	2303	5000 [2270]	5100 [2315]	4945 [2243]	5100 [2313]					
3000	2250	3320	2660	2315	2468	5225 [2372]		5180 [2350]						
3500	2600	3855	3085	2685	2618	5550 [2520]		5490 [2490]						



1. For type 'T' Lineator use enclosure and weights from the next size up.

Dimensions

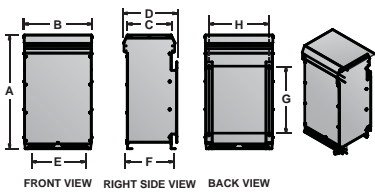

'SU1', 'SU2', 'SU3' ENCLOSURE

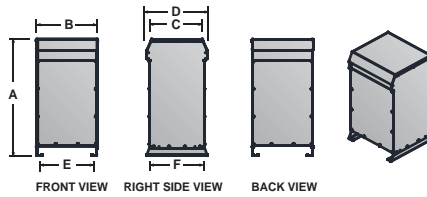

'SU4' ENCLOSURE

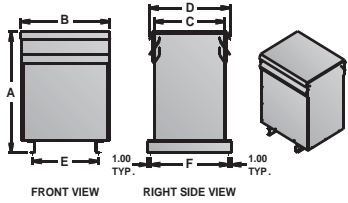

'MT3', 'MT4', 'LT' ENCLOSURE

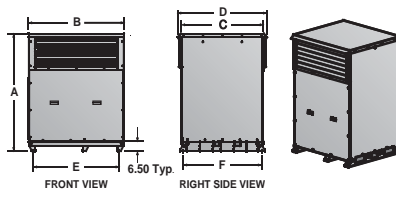

'HT' ENCLOSURE

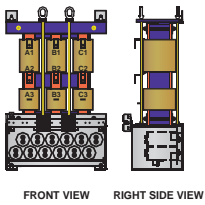

FRONT VIEW RIGHT SIDE VIEW

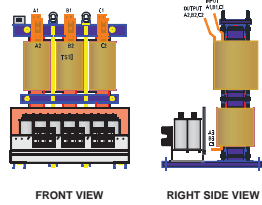

FRONT VIEW RIGHT SIDE VIEW

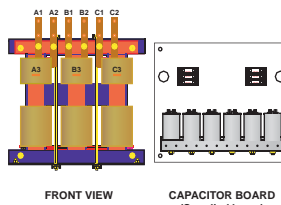

FRONT VIEW CAPACITOR BOARD (Supplied loose)

'E0P' PANEL/BASE MOUNT

'E0' OPEN STYLE

'E0M' MODULAR

CASE STYLE		DIMENSIONS - inches [mm]							
Standard	Enhanced	A	B	C	D	E	F	G	H
SU1	SU1-E	23.50 [597]	11.25 [286]	8.75 [222]	11.25 [286]	8.00 [203]	9.00 [229]	13.00 [330]	9.00 [229]
SU2	SU2-E	29.50 [749]	13.25 [336]	10.25 [260]	12.75 [324]	9.00 [229]	10.00 [254]	16.00 [406]	11.00 [279]
SU3	SU3-E	34.00 [864]	20.25 [514]	13.25 [336]	16.00 [406]	17.50 [445]	13.00 [330]	20.00 [508]	18.00 [457]
SU4	SU4-E	40.00 [1016]	22.00 [559]	18.50 [470]	23.00 [584]	20.00 [508]	20.00 [508]		
MT3	MT3-E	45.00 [1143]	26.00 [661]	21.00 [534]	25.00 [635]	21.50 [546]	19.00 [483]		
MT4	MT4-E	51.50 [1308]	32.00 [813]	25.50 [648]	29.50 [749]	23.50 [597]	23.50 [597]		
LT1	LT1-E	59.00 [1499]	39.50 [1003]	30.00 [762]	34.00 [864]	24.00 [610]	32.00 [813]		
LT2	LT2-E	66.00 [1677]	44.00 [1118]	34.00 [864]	38.00 [965]	26.00 [660]	36.00 [915]		
LT3	LT3-E	75.00 [1905]	48.50 [1232]	39.00 [991]	43.00 [1092]	27.50 [699]	41.00 [1041]		
HT2	HT2-E	78.00 [1981]	58.50 [1486]	51.00 [1295]	56.25 [1428]	52.50 [1333]	50.75 [1289]		
HT3	HT3-E	84.00 [2134]	68.50 [1740]	59.00 [1499]	64.50 [1638]	62.50 [1587]	58.75 [1492]		

Ordering Information

Model	Motor Horsepower	Line Voltage	Frequency	Load Type	Enclosure Type	Optional
AUHF -	HP -	VVV -	Hz -	L -	En -	O
Advanced	5	208	50	D ^[1]	E0	E
Universal	to	240	60	Diode Bridge	No Enclosure	Nema 3R
Harmonic	3500	400		Rectifier	Base Mount Only	[IP23]
Filter		440		T ^[2]	(5 to 1400HP)	Enhanced
		480		Thyristor Bridge	E0P	HP
		600		Rectifier	No Enclosure	High
		690			Panel/Wall Mountable	Performance
		(VAC)			(5 to 125HP)	
					E0M	ED
					Modular (Caps. shipped Loose)	Extreme Duty
					(400 to 3500HP)	MD
					E1	Marine Duty
					Nema 3R [IP23]	
					Ventilated Enclosure	
					(5 to 3500HP)	

- 'D' type AUHF is suitable for standard diode bridge and diode/SCR precharged front-end VSD's.
- 'T' type AUHF is suitable for DC drives, Current Source Inverters and other controlled rectifier loads.

General Specifications:

HP / kW RATING:

Available for motor/drive system sizes up to 3500HP / 2600kW

VOLTAGE:

Standard voltages up to 690V, 3-phase

FREQUENCY:

50 or 60Hz

OVERLOAD CAPABILITY:

Suitable for overload of 150% for 60 seconds every 10 minutes

HARMONICS TREATED:

5th, 7th, 11th, 13th, ...

K-FACTOR SUITABILITY:

Up to 20

INPUT K-FACTOR:

Reduced to <1.5

INPUT CURRENT DISTORTION:

<8% at full load [<5% available]

SHORT CIRCUIT RATING:

100kAIC

NO LOAD CAPACITIVE REACTANCE (kVAR) LEVELS:

5 to 75HP 15 to 20%
100 to 3500HP 10 to 15%

EFFICIENCY:

>99%

ELEVATION:

3300ft [1000m] above sea level

VENTILATION:

Convection air cooled

ENCLOSURE:

NEMA 3R [IP23]

Paint: Polyester powder coated

Color: ANSI 61 Grey

OPTIONAL:

Nema 3R [IP23] Enhanced

DNV or Lloyds Certification

Lineator-ED Selection Curve

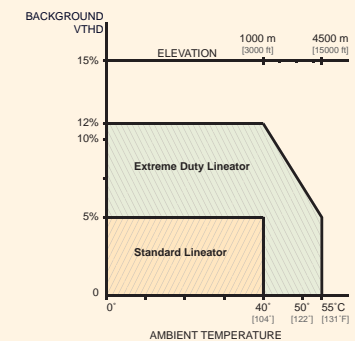

Typical Lineator Configurations

Standalone VSD System

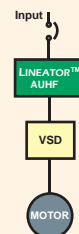

VSD System with Bypass*

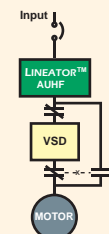

Multiple VSD System

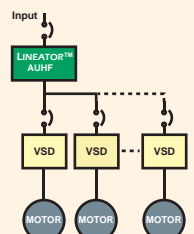

* When the VSD requires a bypass, the LINEATOR does not require bypassing. It will provide 'Reduce Voltage Reactor Start' which gives a smooth ramp to full speed with built in ramp and full load power factor correction.





Expect better. Call us.

To discuss how MIRUS can help you meet your power quality challenges, contact us at our head office:

MIRUS International Inc.
31 Sun Pac Blvd.
Brampton, Ontario
Canada L6S 5P6

Tel: (905) 494-1120

Fax: (905) 494-1140

Toll-Free: 1-888-TO MIRUS (888-866-4787)

www.mirusinternational.com



Harmonic and Energy Solutions

**Real-world performance
for real-world loads.**